

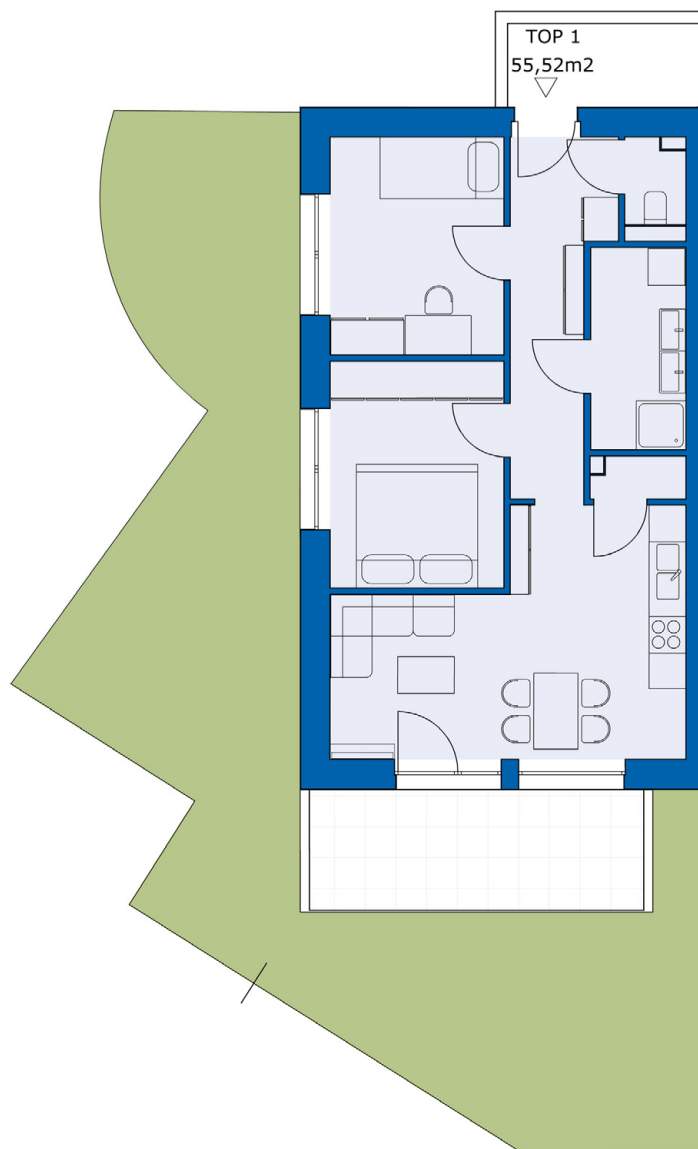

## Tiergartenweg 32a – 32e | 8055 Graz

IFA Bauherrenmodell Plus N°495.

Ihre geförderte und steuerlich begünstigte Ertragsimmobilie mit Wohnungseigentum.



## Tiergartenweg 32e | 8055 Graz

### TOP 01 / ERDGESCHOSS

Wohnfläche	55,52 m <sup>2</sup>
Garten	66,00 m <sup>2</sup>
Terrasse	10,74 m <sup>2</sup>
Kellerabteil	Nr. 01
Tiefgaragen-Stellplatz	Nr. 09

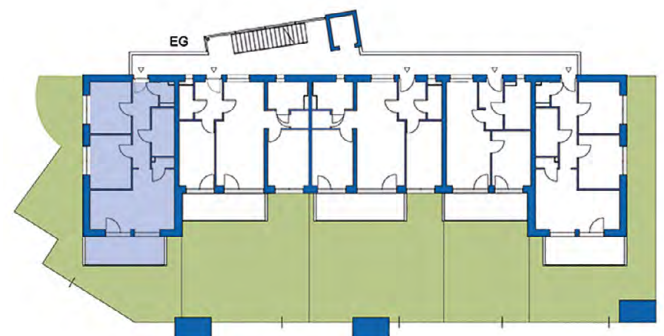

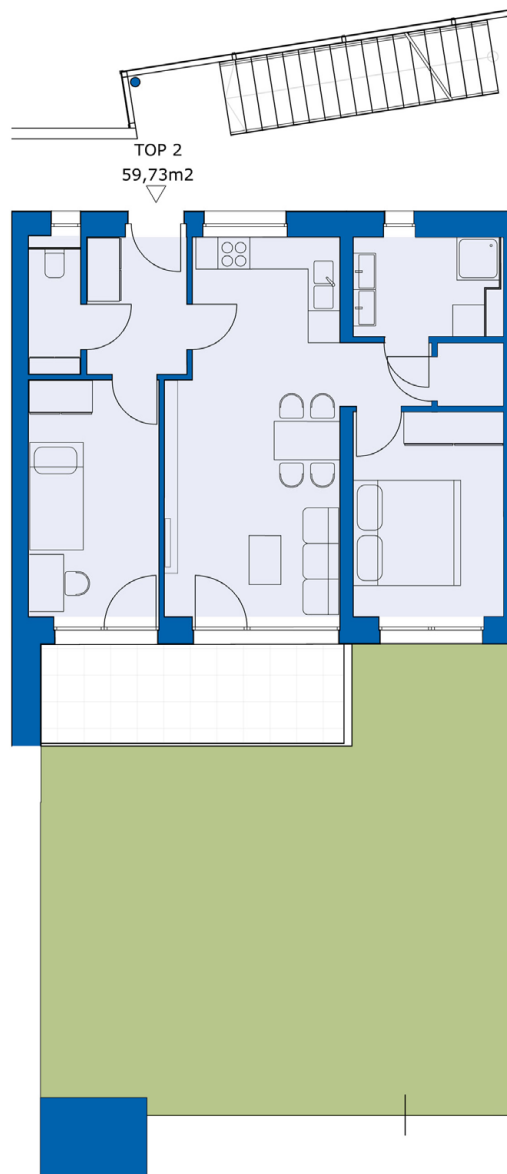

## Tiergartenweg 32e | 8055 Graz

### TOP 02 / ERDGESCHOSS

Wohnfläche	59,73 m <sup>2</sup>
Garten	65,60 m <sup>2</sup>
Terrasse	10,62 m <sup>2</sup>
Kellerabteil	Nr. 02
Tiefgaragen-Stellplatz	Nr. 10

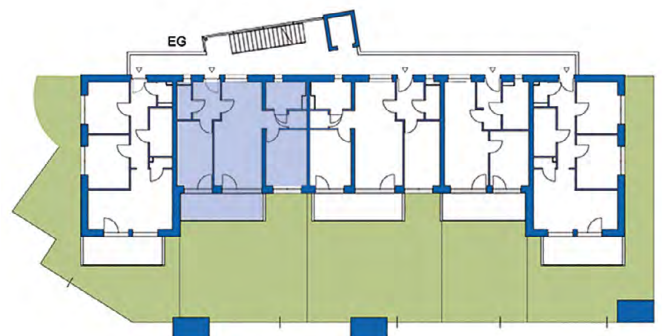

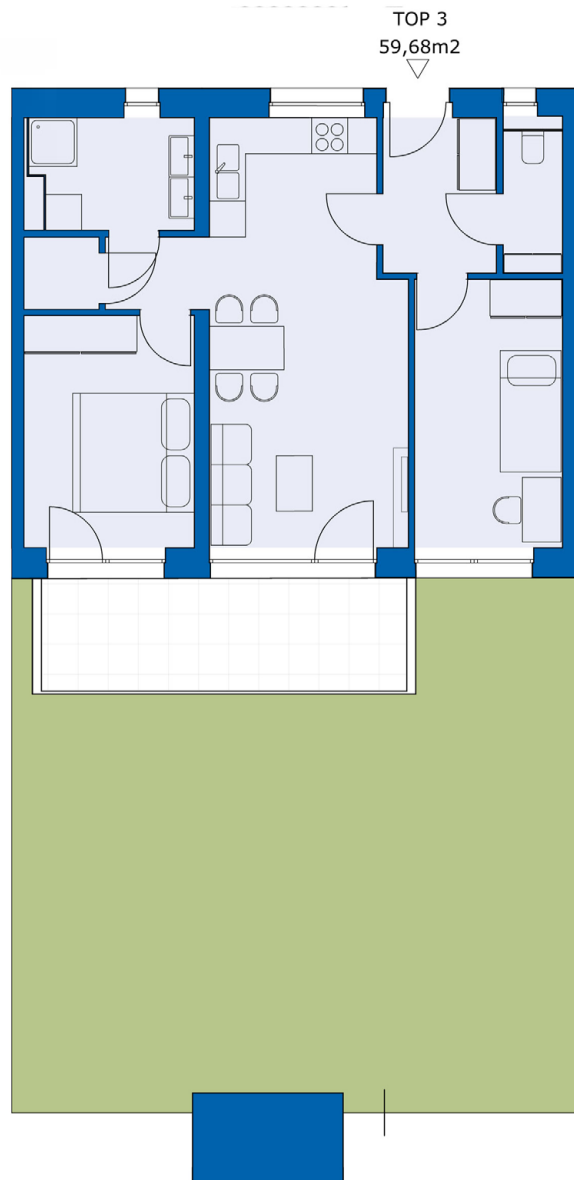

## Tiergartenweg 32e | 8055 Graz

### TOP 03 / ERDGESCHOSS

Wohnfläche	59,68 m <sup>2</sup>
Garten	66,18 m <sup>2</sup>
Terrasse	11,38 m <sup>2</sup>
Kellerabteil	Nr. 03
Tiefgaragen-Stellplatz	Nr. 11

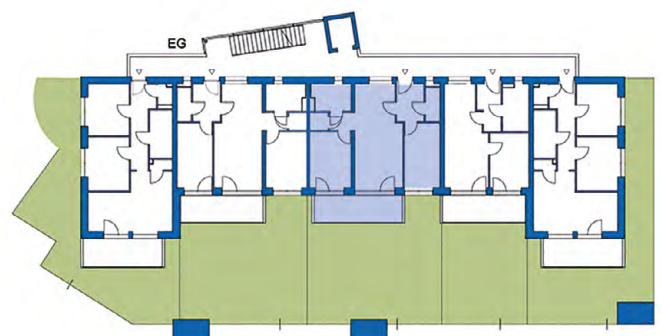

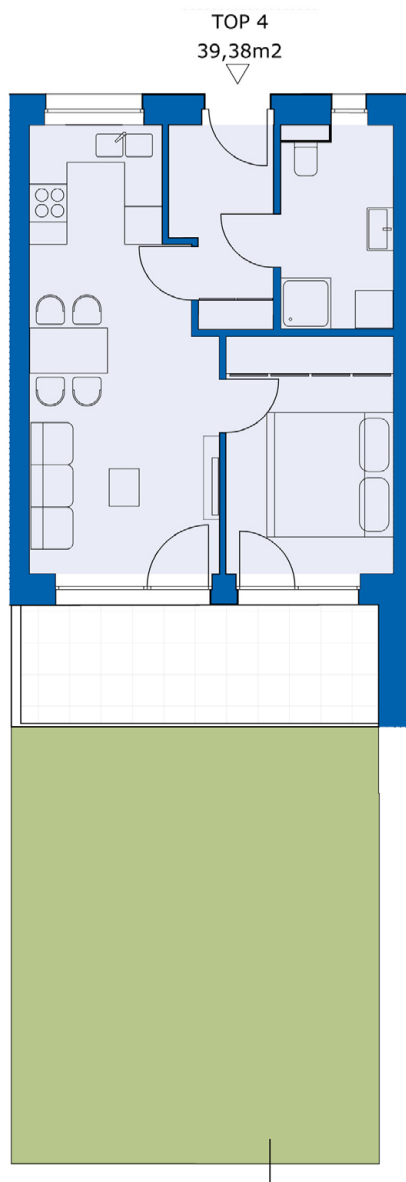

## Tiergartenweg 32e | 8055 Graz

### TOP 04 / ERDGESCHOSS

Wohnfläche	39,38 m <sup>2</sup>
Garten	43,95 m <sup>2</sup>
Terrasse	10,75 m <sup>2</sup>
Kellerabteil	Nr. 04
Tiefgaragen-Stellplatz	Nr. 12

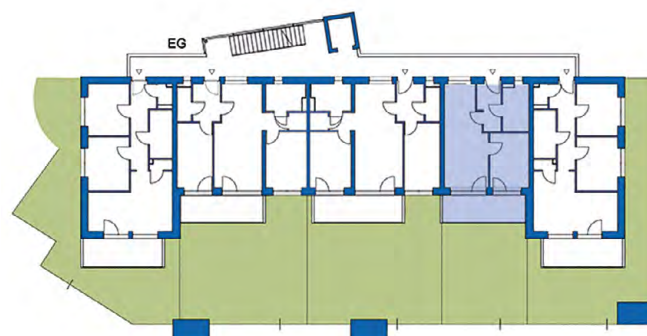

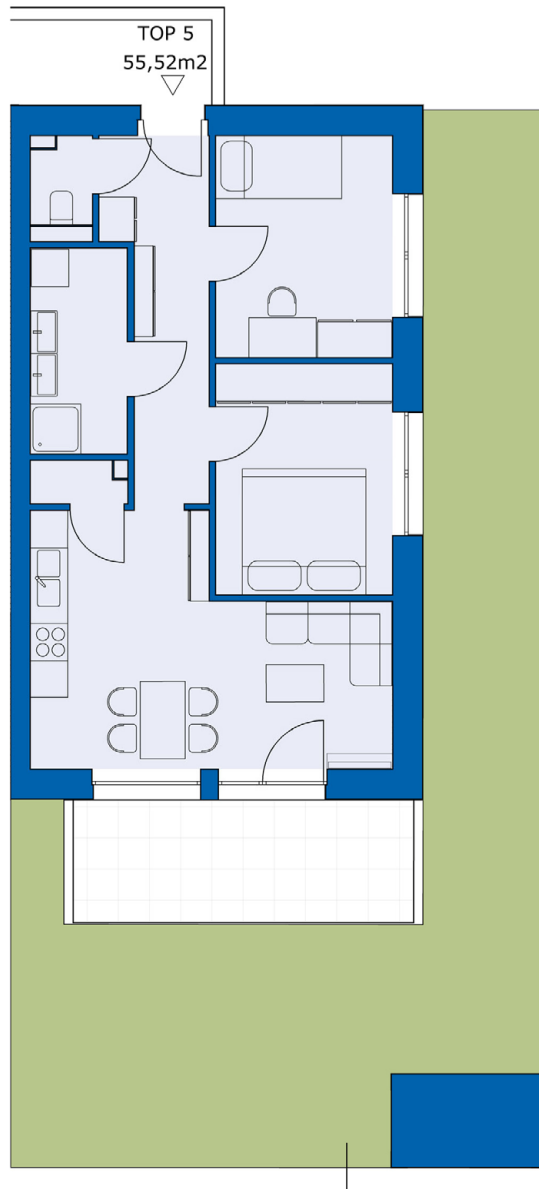

## Tiergartenweg 32e | 8055 Graz

### TOP 05 / ERDGESCHOSS

Wohnfläche	55,52 m <sup>2</sup>
Garten	58,69 m <sup>2</sup>
Terrasse	10,74 m <sup>2</sup>
Kellerabteil	Nr. 05
Tiefgaragen-Stellplatz	Nr. 43

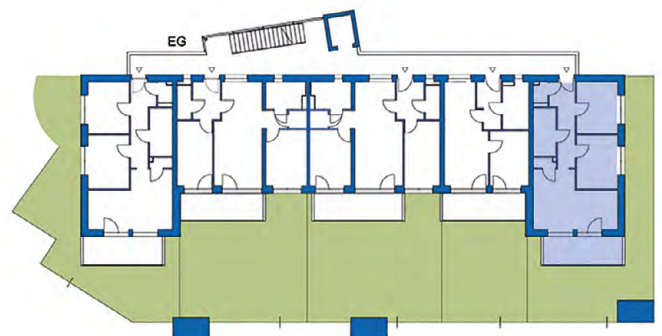

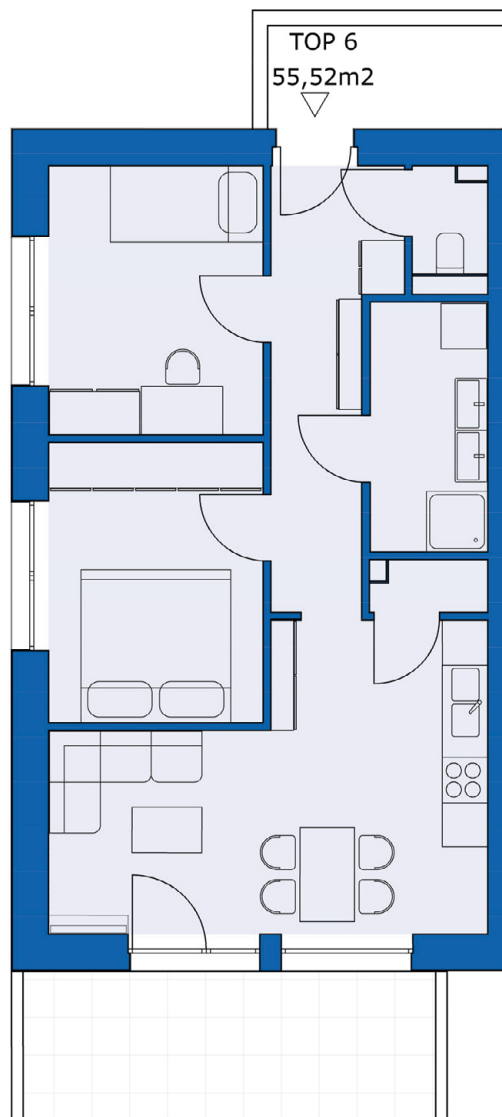

## Tiergartenweg 32e | 8055 Graz

### TOP 06 / 1. OBERGESCHOSS

Wohnfläche	55,52 m <sup>2</sup>
Balkon	10,74 m <sup>2</sup>
Kellerabteil	Nr. 06
Tiefgaragen-Stellplatz	Nr. 44

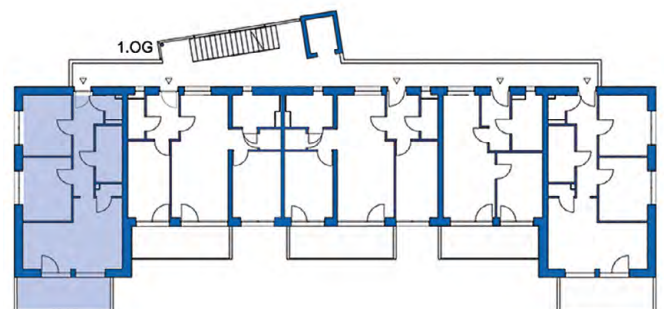

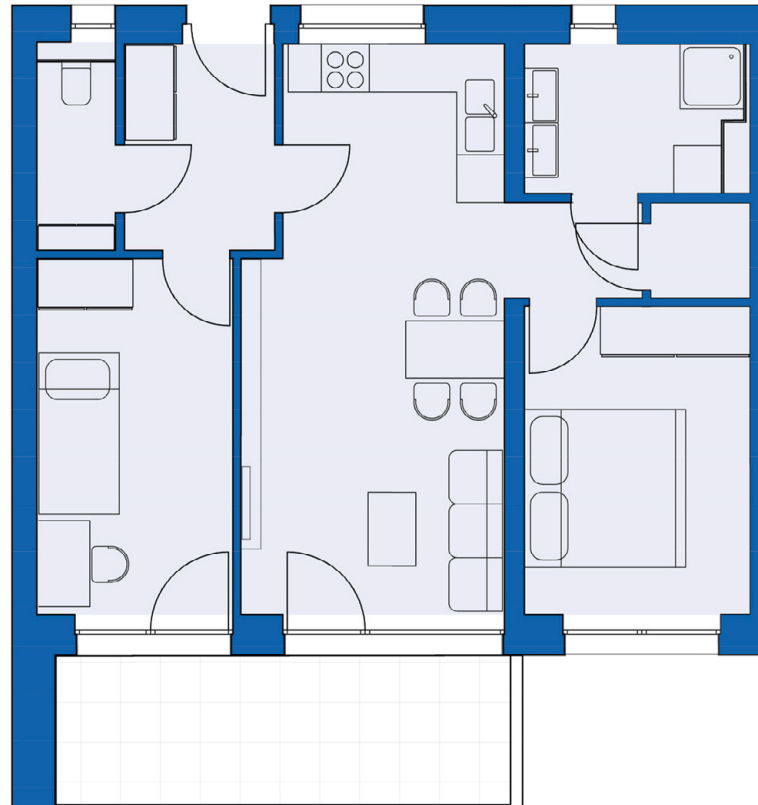
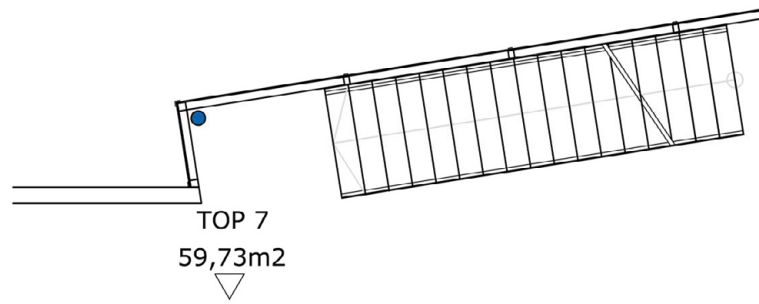

**Tiergartenweg 32e** | 8055 Graz

TOP 07 / 1. OBERGESCHOSS

Wohnfläche	59,73 m <sup>2</sup>
Balkon	10,62 m <sup>2</sup>
Kellerabteil	Nr. 07
Tiefgaragen-Stellplatz	Nr. 45

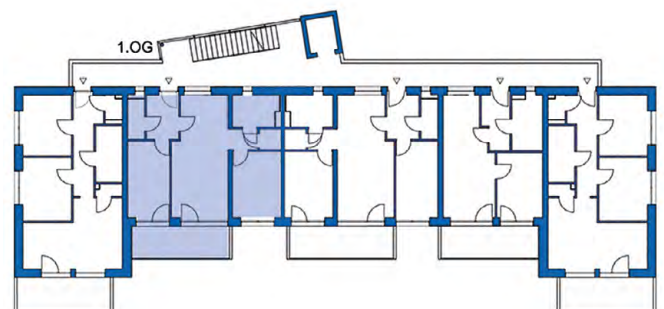



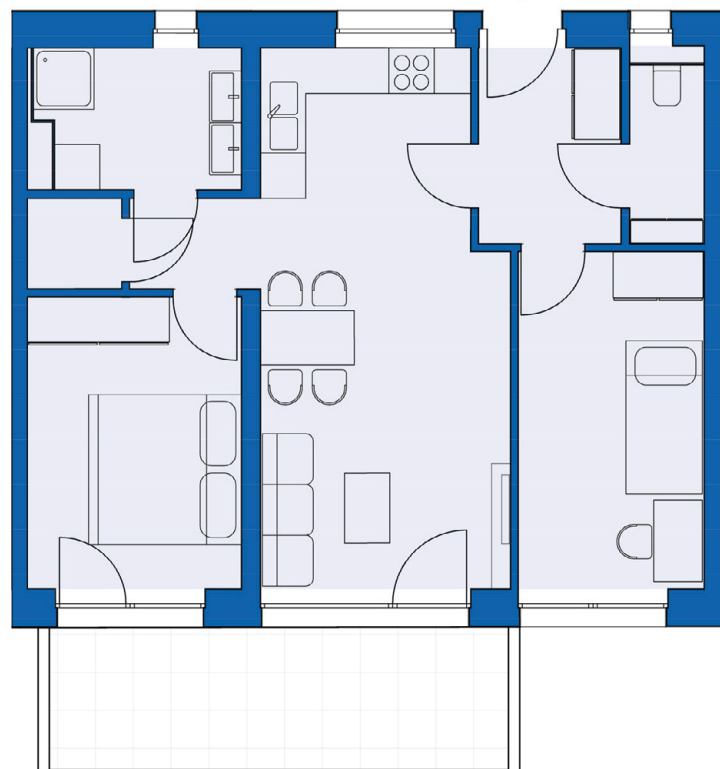
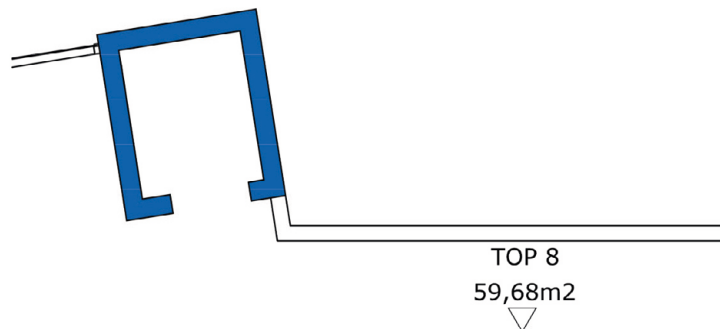

**Tiergartenweg 32e** | 8055 Graz

**TOP 08 / 1. OBERGESCHOSS**

Wohnfläche	59,68 m <sup>2</sup>
Balkon	11,38 m <sup>2</sup>
Kellerabteil	Nr. 08
Tiefgaragen-Stellplatz	Nr. 46

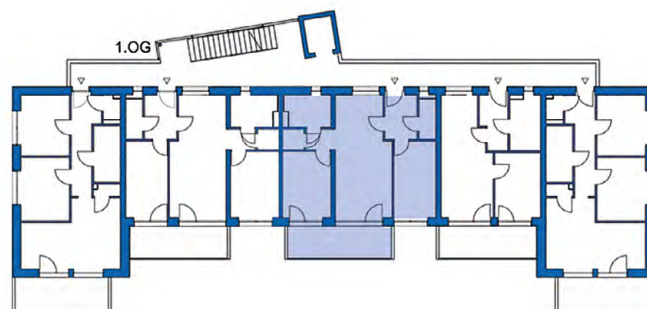

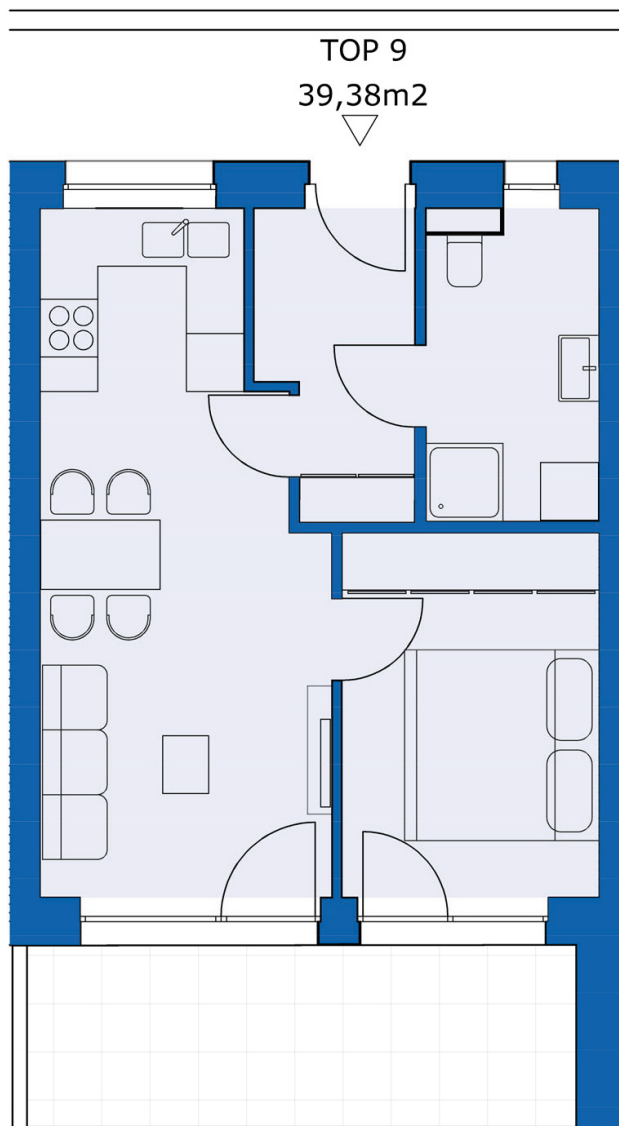

## Tiergartenweg 32e | 8055 Graz

### TOP 09 / 1. OBERGESCHOSS

Wohnfläche	39,38 m <sup>2</sup>
Balkon	10,75 m <sup>2</sup>
Kellerabteil	Nr. 09
Tiefgaragen-Stellplatz	Nr. 29

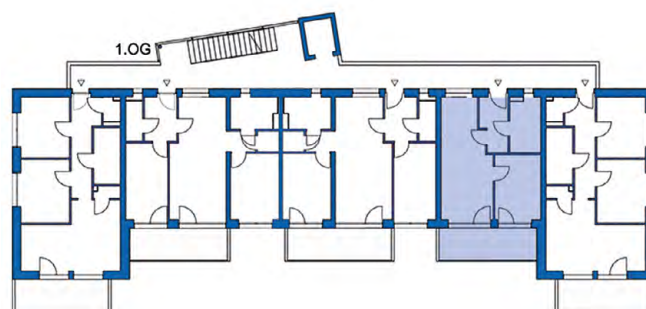

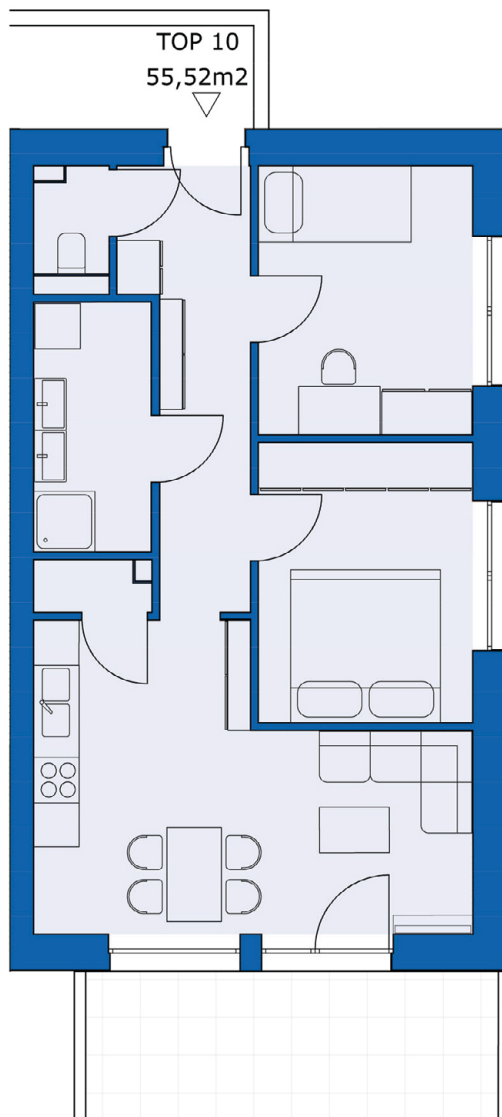

## Tiergartenweg 32e | 8055 Graz

### TOP 10 / 1. OBERGESCHOSS

Wohnfläche	55,52 m <sup>2</sup>
Balkon	10,74 m <sup>2</sup>
Kellerabteil	Nr. 10
Tiefgaragen-Stellplatz	Nr. 30

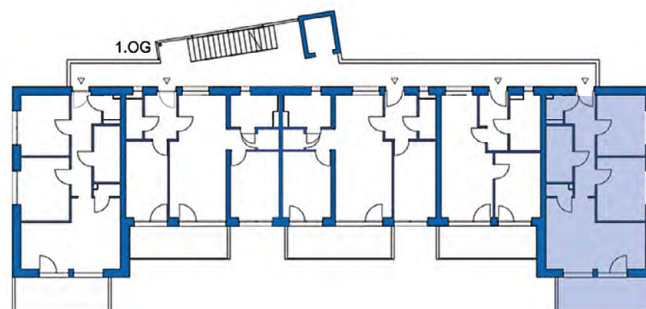

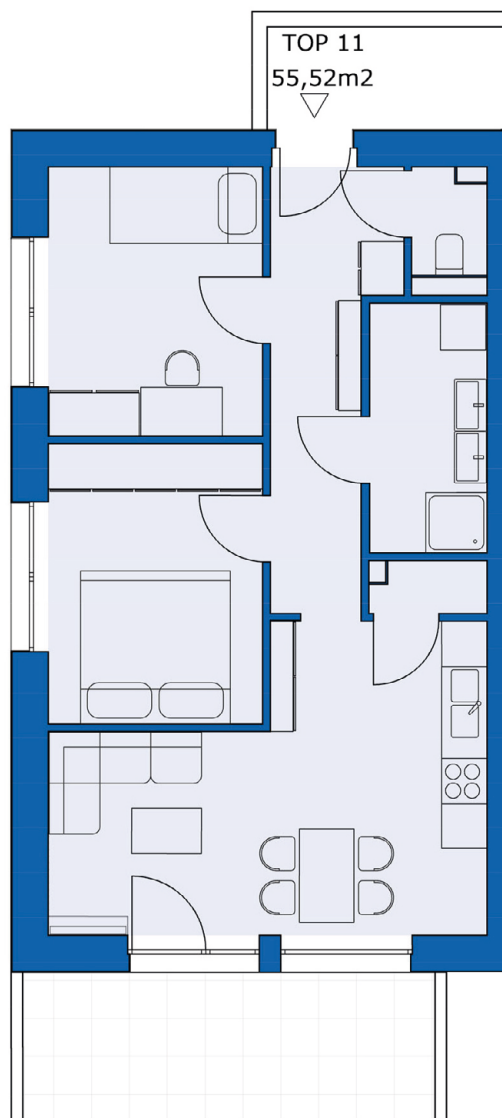

## Tiergartenweg 32e | 8055 Graz

### TOP 11 / 2. OBERGESCHOSS

Wohnfläche	55,52 m <sup>2</sup>
Balkon	10,74 m <sup>2</sup>
Kellerabteil	Nr. 11
Tiefgaragen-Stellplatz	Nr. 31

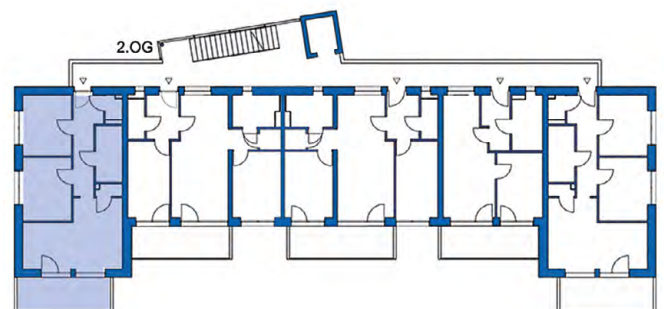

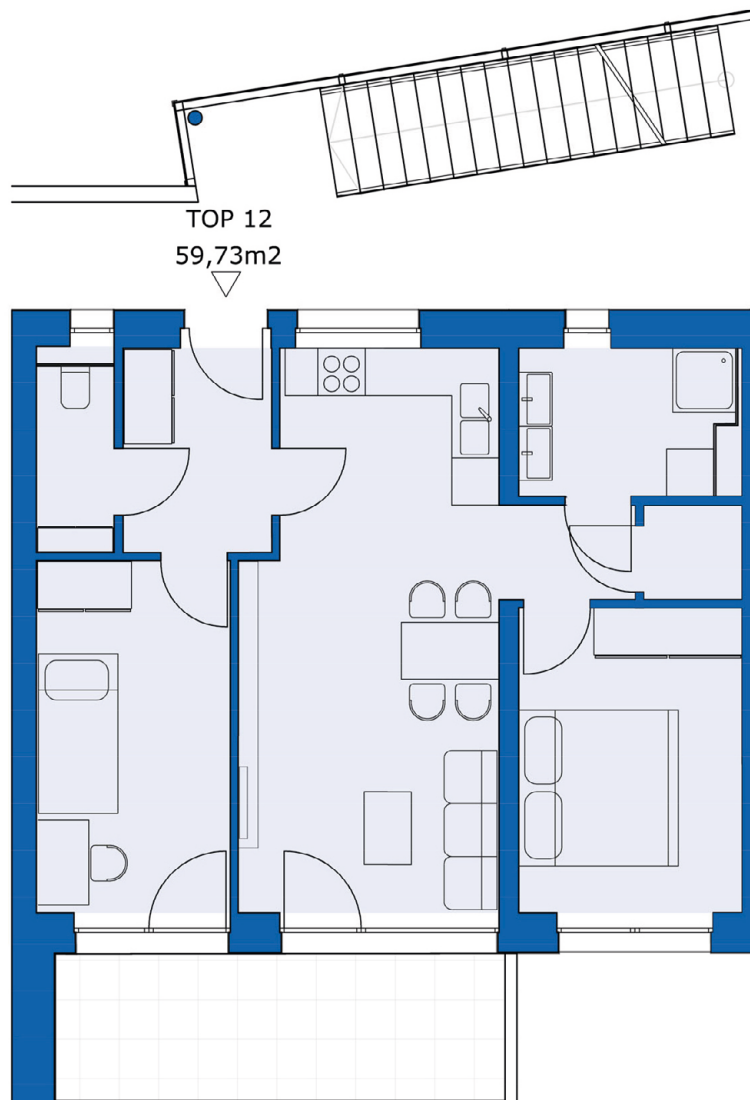

**Tiergartenweg 32e** | 8055 Graz

TOP 12 / 2. OBERGESCHOSS

Wohnfläche	59,73 m <sup>2</sup>
Balkon	10,62 m <sup>2</sup>
Kellerabteil	Nr. 12
Tiefgaragen-Stellplatz	Nr. 32

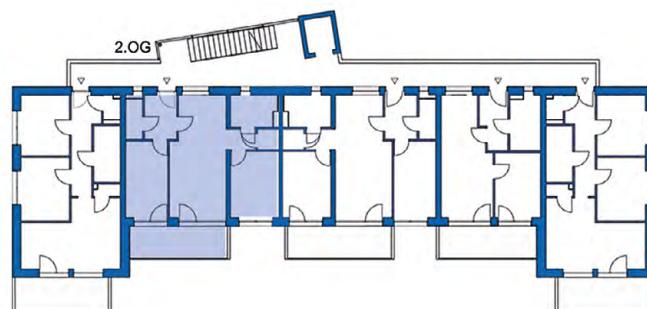

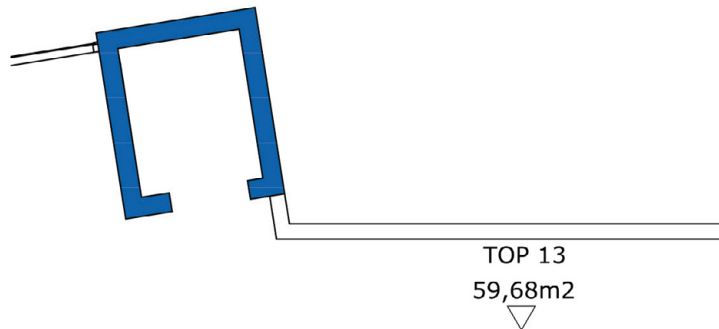

TOP 13  
59,68m<sup>2</sup>

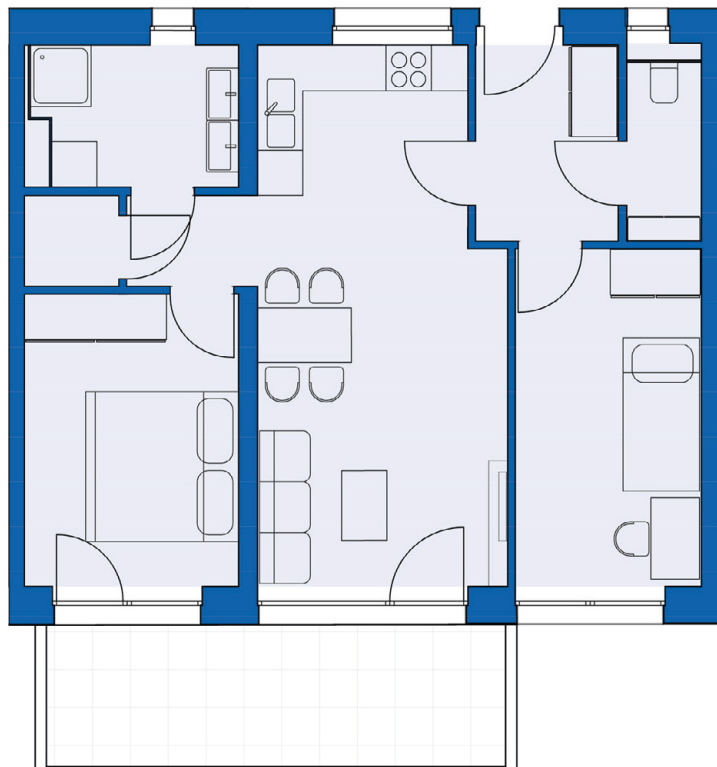

## Tiergartenweg 32e | 8055 Graz

### TOP 13 / 2. OBERGESCHOSS

Wohnfläche	59,68 m <sup>2</sup>
Balkon	11,38 m <sup>2</sup>
Kellerabteil	Nr. 13
Tiefgaragen-Stellplatz	Nr. 33

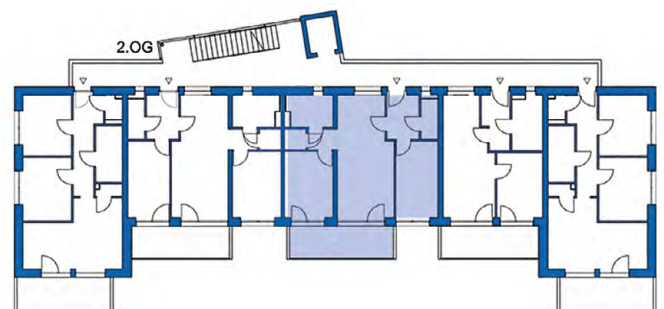

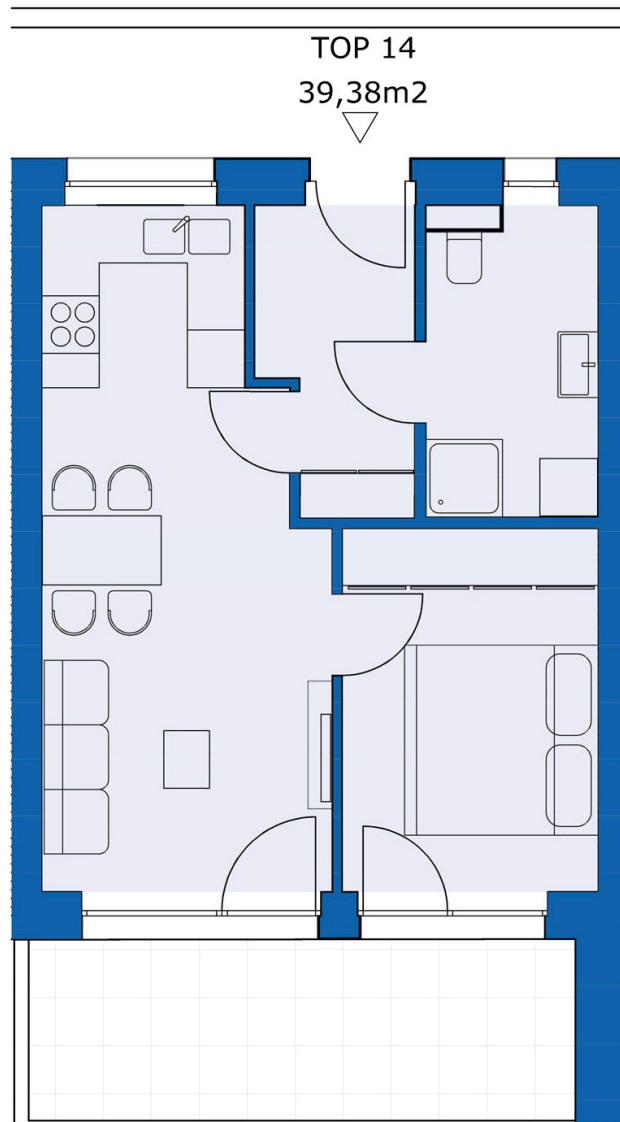

**Tiergartenweg 32e** | 8055 Graz

TOP 14 / 2. OBERGESCHOSS

Wohnfläche	39,38 m <sup>2</sup>
Balkon	10,75 m <sup>2</sup>
Kellerabteil	Nr. 14
Tiefgaragen-Stellplatz	Nr. 34

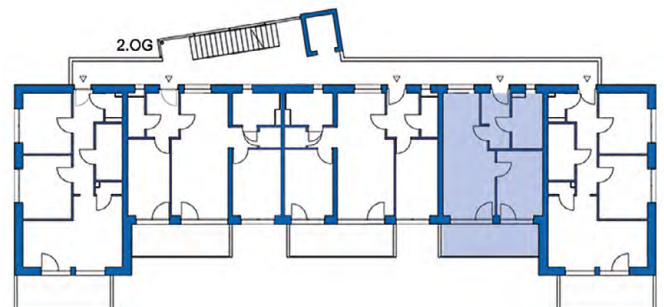

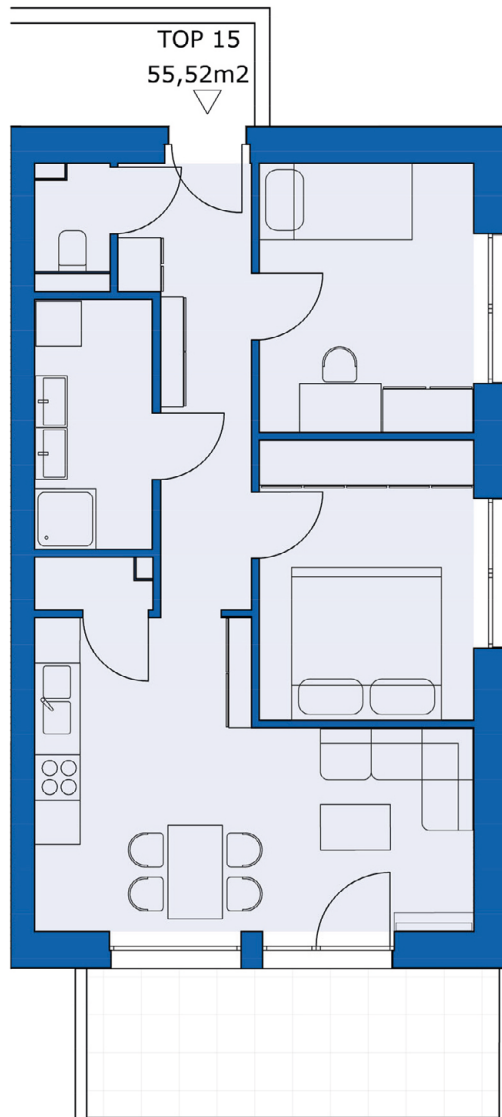

## Tiergartenweg 32e | 8055 Graz

### TOP 15 / 2. OBERGESCHOSS

Wohnfläche	55,52 m <sup>2</sup>
Balkon	10,74 m <sup>2</sup>
Kellerabteil	Nr. 15
Tiefgaragen-Stellplatz	Nr. 42

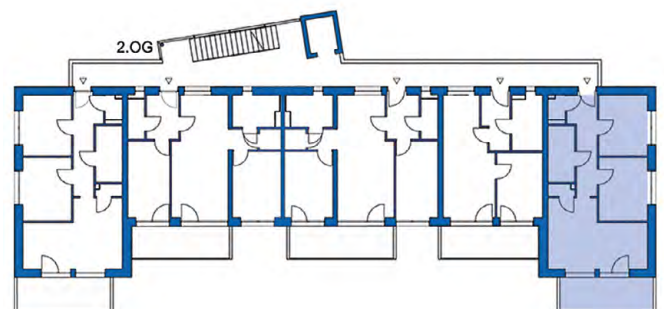



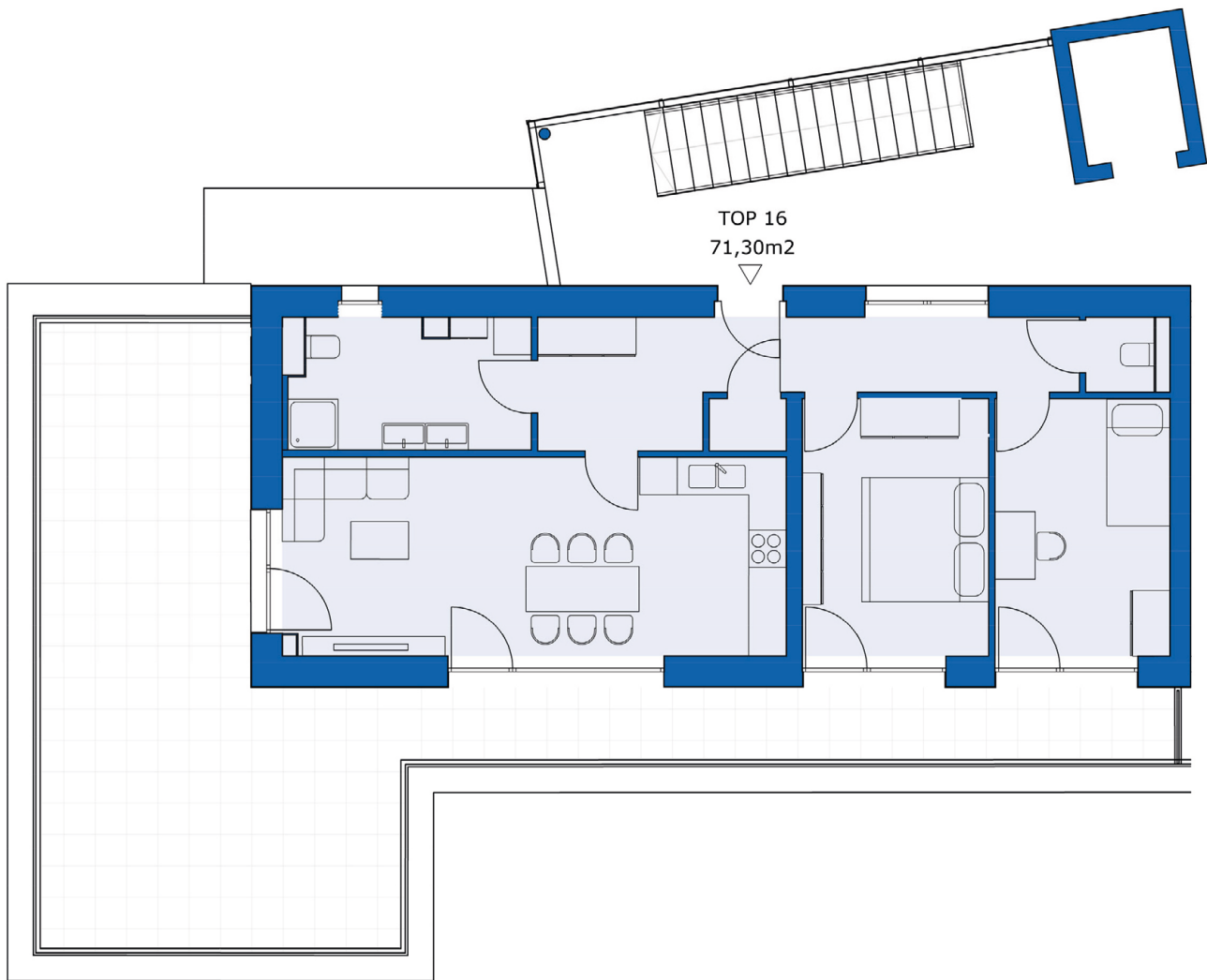

**Tiergartenweg 32e** | 8055 Graz

**TOP 16 / DACHGESCHOSS**

Wohnfläche	71,30 m <sup>2</sup>
Terrasse	58,10 m <sup>2</sup>
Kellerabteil	Nr. 16
Tiefgaragen-Stellplatz	Nr. 13 und 14

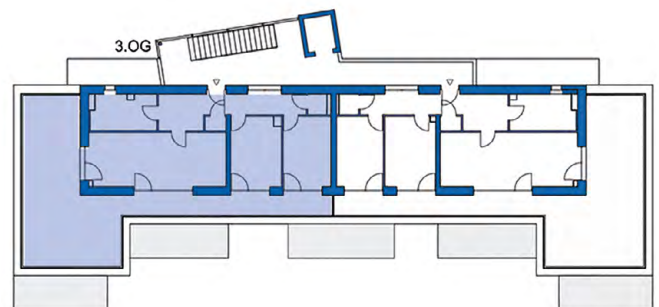

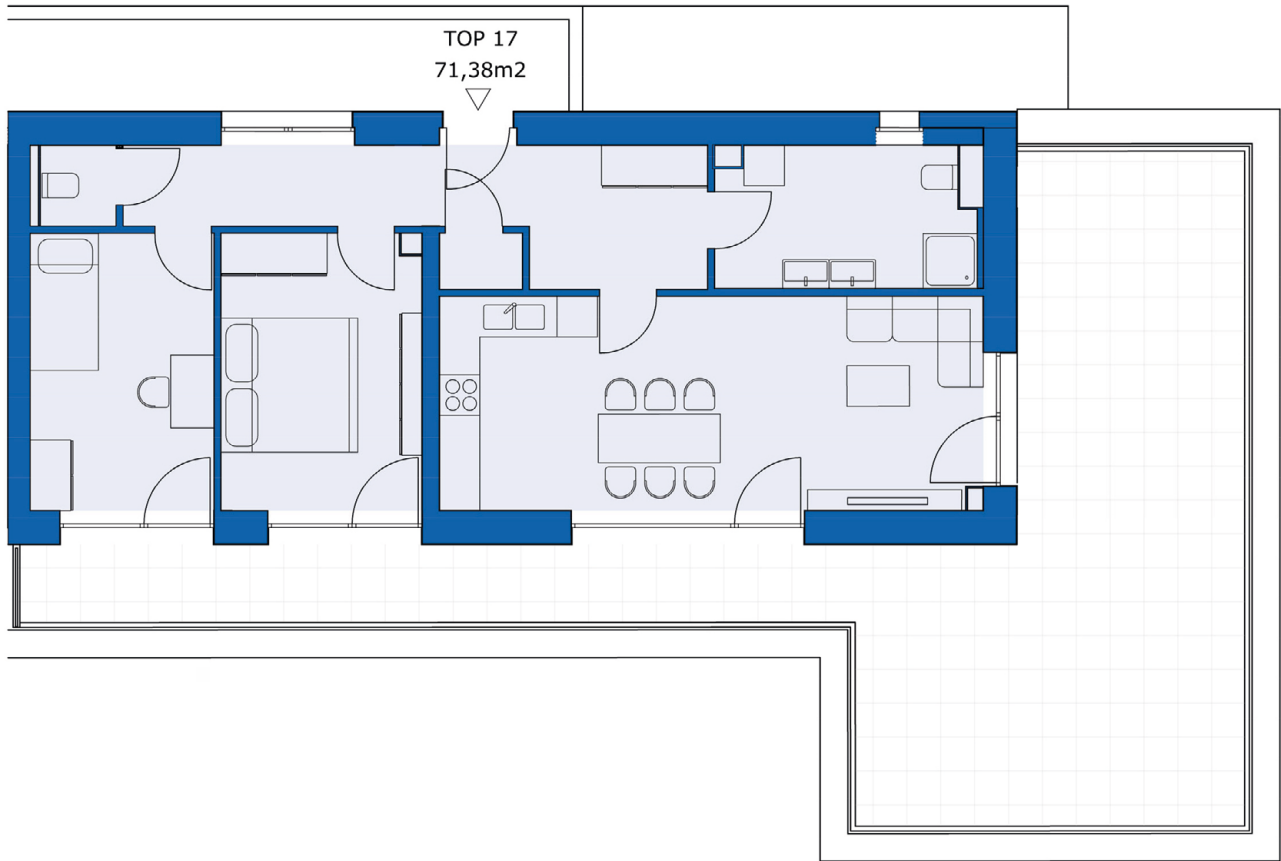

**Tiergartenweg 32e** | 8055 Graz

**TOP 17 / DACHGESCHOSS**

Wohnfläche	71,38 m <sup>2</sup>
Terrasse	58,10 m <sup>2</sup>
Kellerabteil	Nr. 17
Tiefgaragen-Stellplatz	Nr. 15 und 16

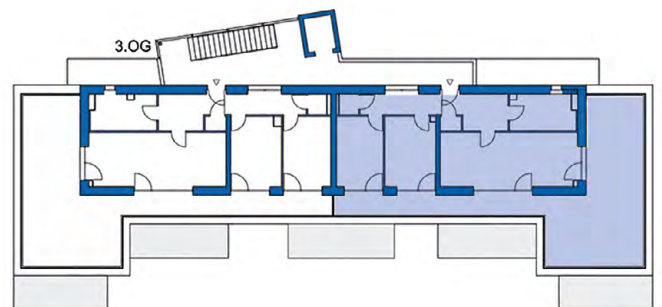

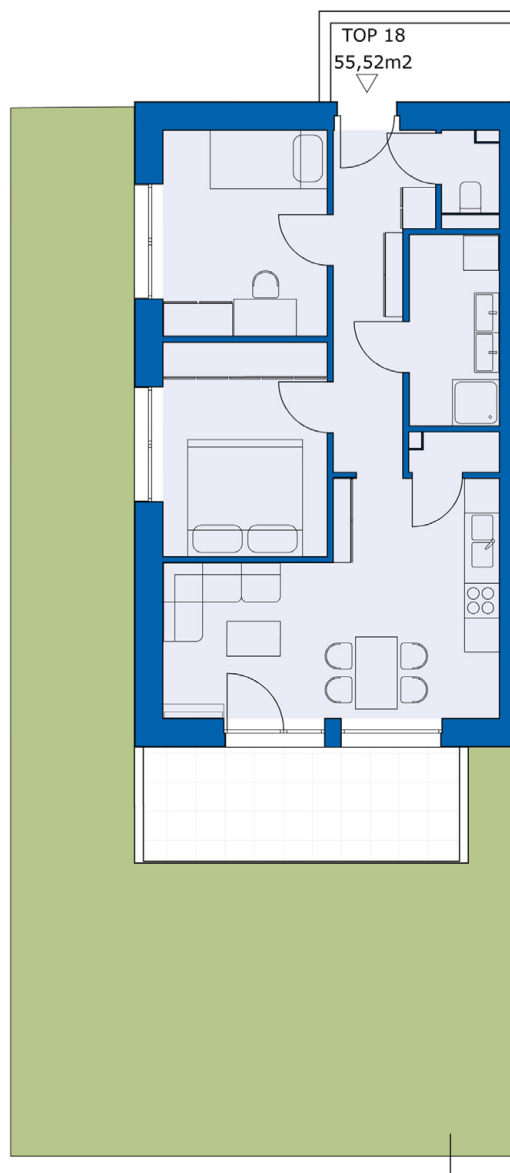

## Tiergartenweg 32d | 8055 Graz

### TOP 18 / ERDGESCHOSS

Wohnfläche	55,52 m <sup>2</sup>
Garten	75,71 m <sup>2</sup>
Terrasse	10,74 m <sup>2</sup>
Kellerabteil	Nr. 18
Tiefgaragen-Stellplatz	Nr. 17

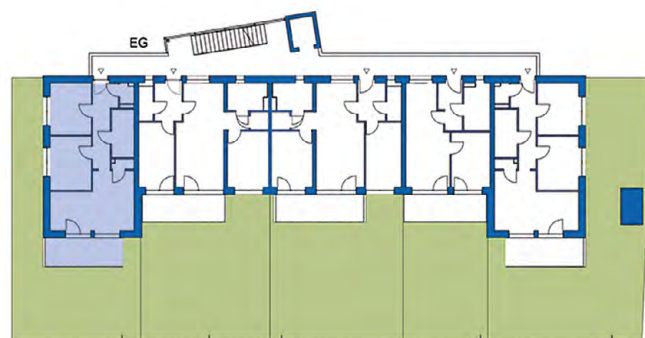

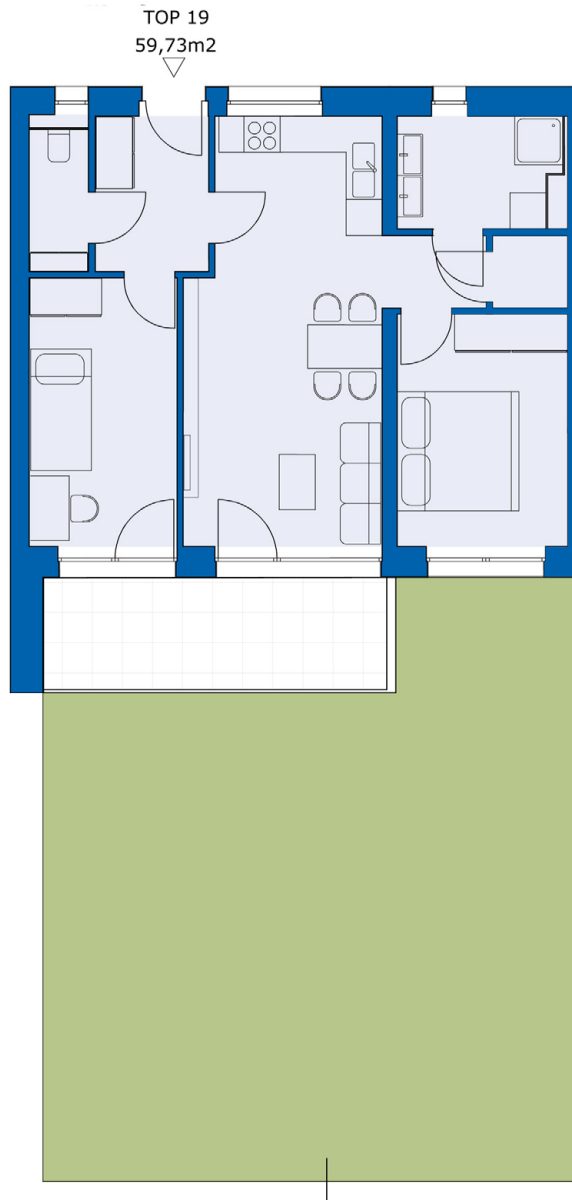

**Tiergartenweg 32d** | 8055 Graz

**TOP 19 / ERDGESCHOSS**

Wohnfläche	59,73 m <sup>2</sup>
Garten	75,53 m <sup>2</sup>
Terrasse	10,62 m <sup>2</sup>
Kellerabteil	Nr. 19
Tiefgaragen-Stellplatz	Nr. 18

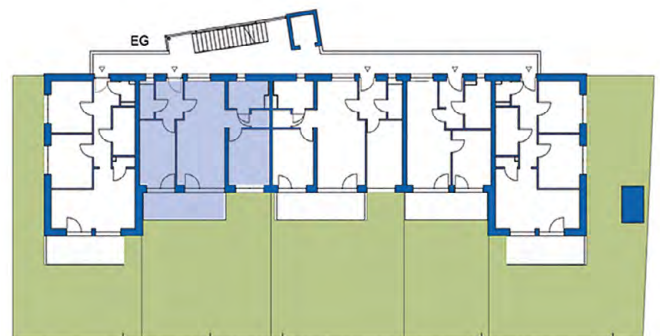

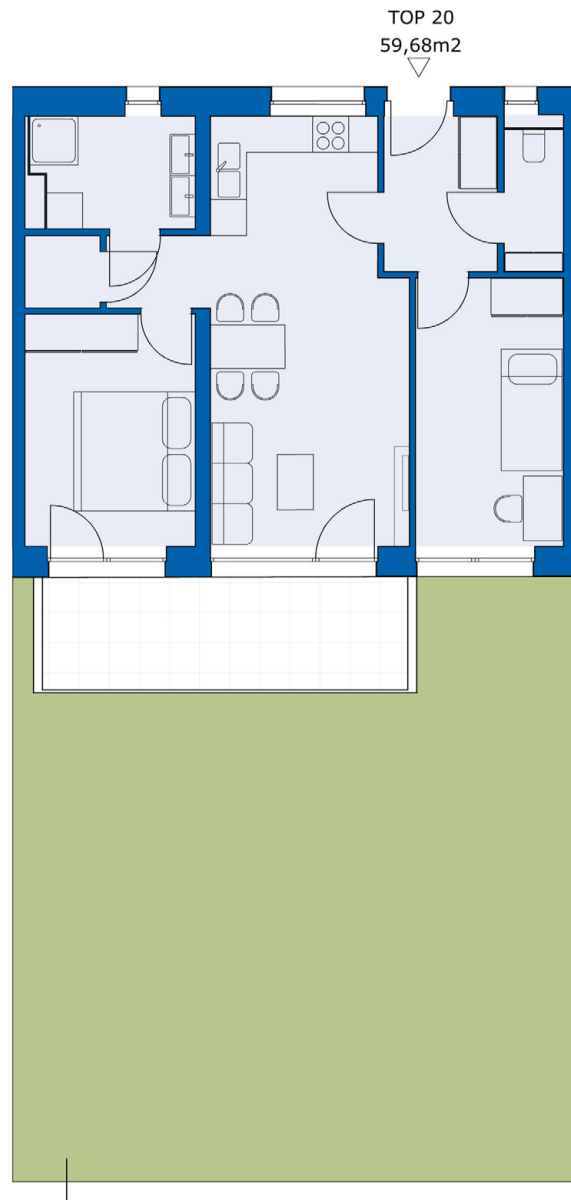

**Tiergartenweg 32d** | 8055 Graz

TOP 20 / ERDGESCHOSS

Wohnfläche	59,68 m <sup>2</sup>
Garten	76,97 m <sup>2</sup>
Terrasse	11,38 m <sup>2</sup>
Kellerabteil	Nr. 20
Tiefgaragen-Stellplatz	Nr. 19

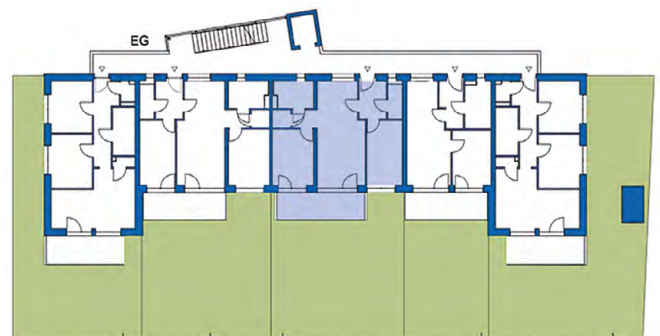

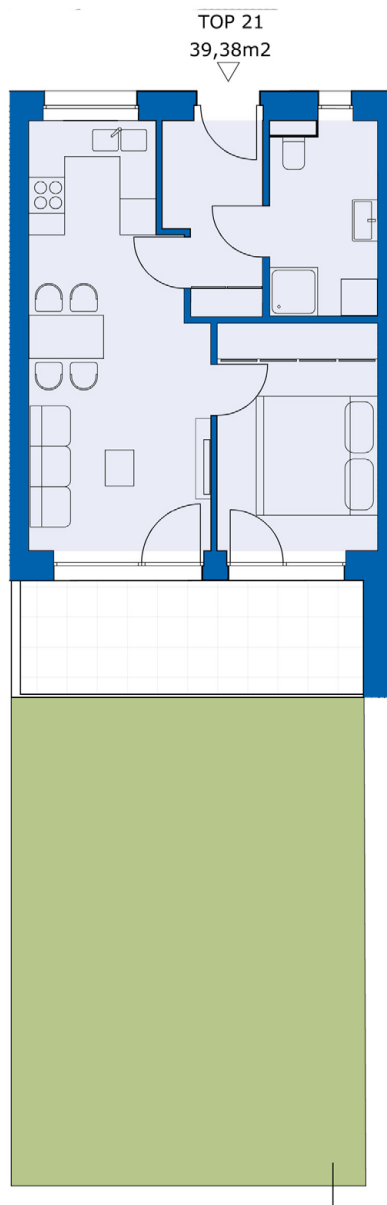

**Tiergartenweg 32d** | 8055 Graz

**TOP 21 / ERDGESCHOSS**

Wohnfläche	39,38 m <sup>2</sup>
Garten	51,28 m <sup>2</sup>
Terrasse	10,75 m <sup>2</sup>
Kellerabteil	Nr. 21
Tiefgaragen-Stellplatz	Nr. 20

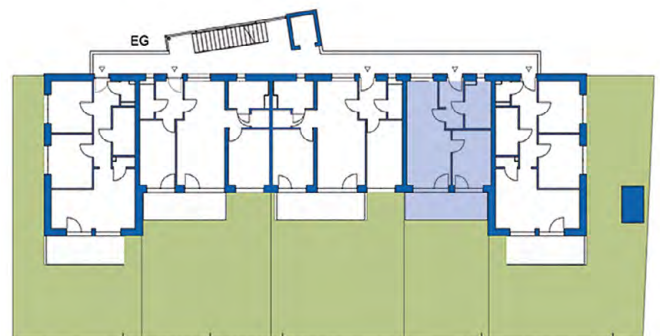

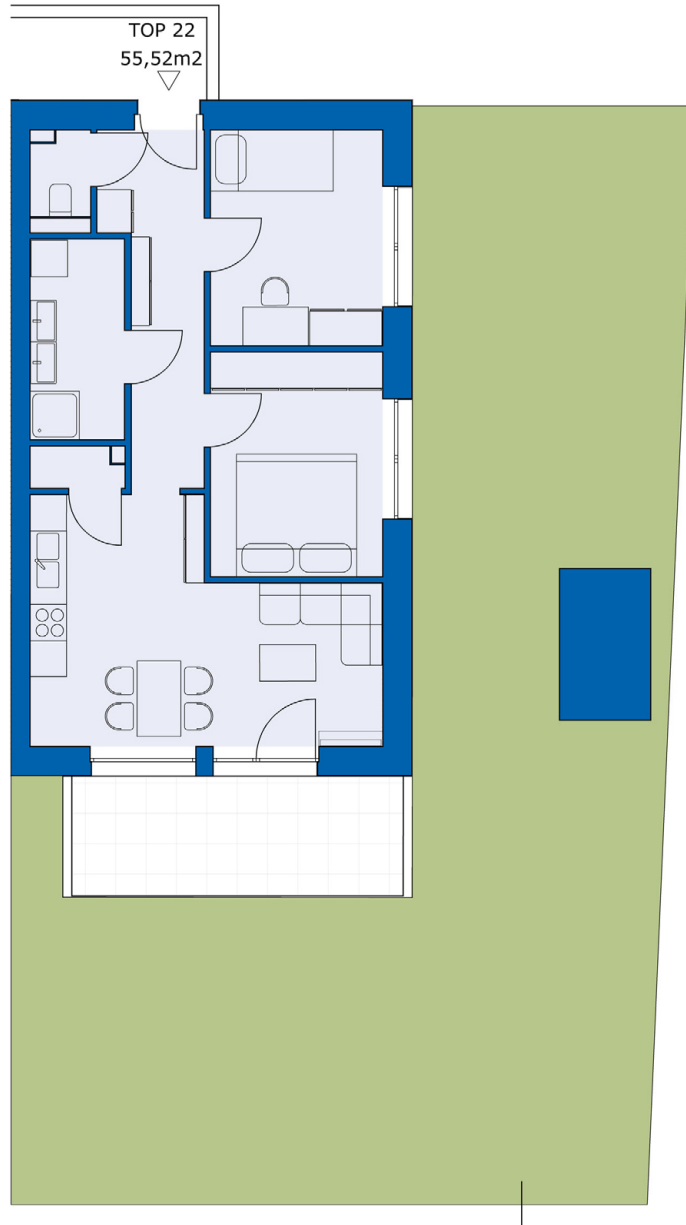

## Tiergartenweg 32d | 8055 Graz

### TOP 22 / ERDGESCHOSS

Wohnfläche	55,52 m <sup>2</sup>
Garten	109,27 m <sup>2</sup>
Terrasse	10,74 m <sup>2</sup>
Kellerabteil	Nr. 22
Tiefgaragen-Stellplatz	Nr. 21

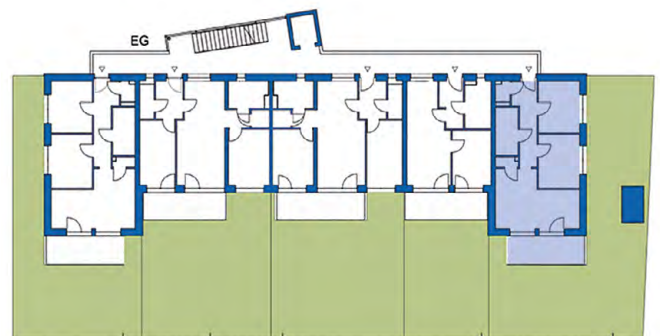

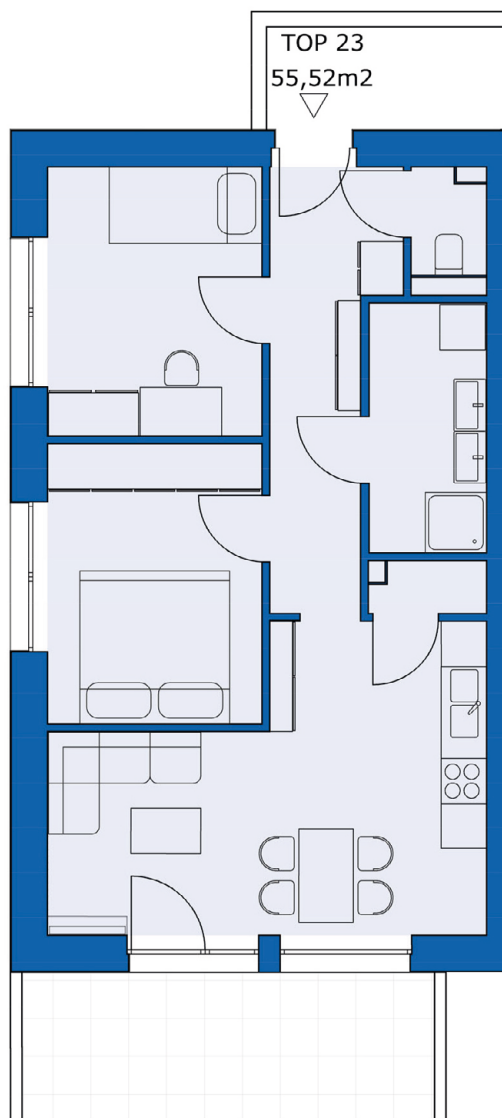

## Tiergartenweg 32d | 8055 Graz

### TOP 23 / 1. OBERGESCHOSS

Wohnfläche	55,52 m <sup>2</sup>
Balkon	10,74 m <sup>2</sup>
Kellerabteil	Nr. 23
Tiefgaragen-Stellplatz	Nr. 22

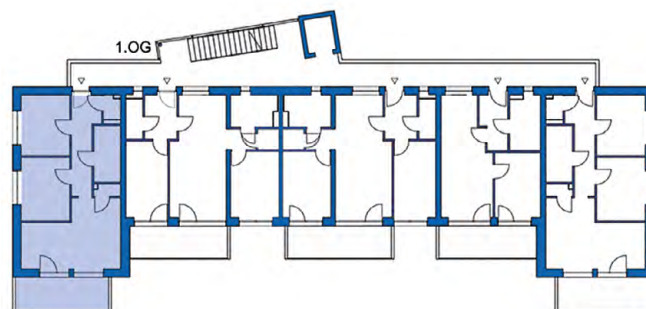



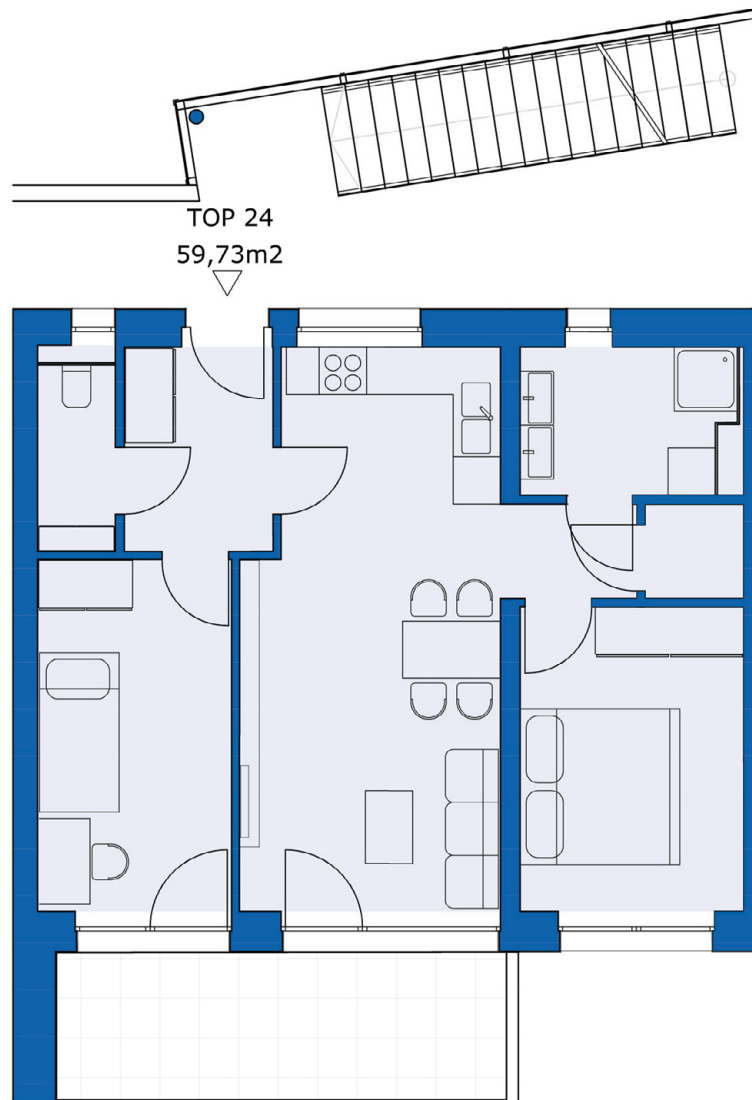

## Tiergartenweg 32d | 8055 Graz

### TOP 24 / 1. OBERGESCHOSS

Wohnfläche	59,73 m <sup>2</sup>
Balkon	10,62 m <sup>2</sup>
Kellerabteil	Nr. 24
Tiefgaragen-Stellplatz	Nr. 23

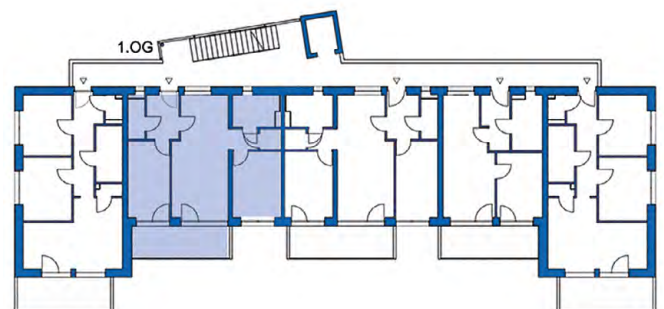

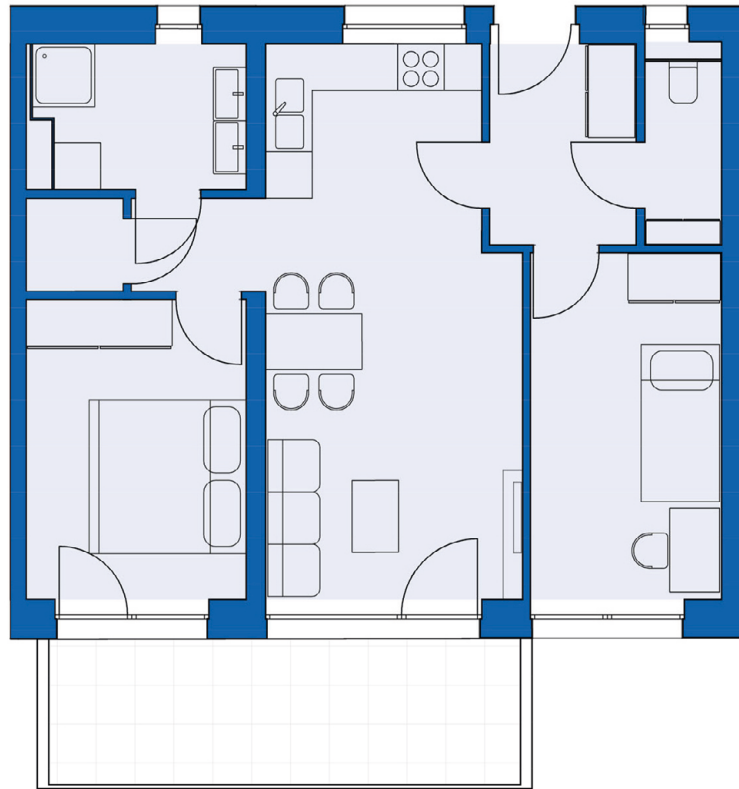
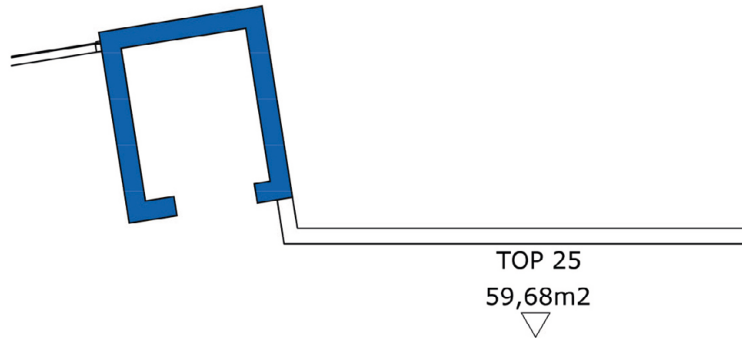

## Tiergartenweg 32d | 8055 Graz

### TOP 25 / 1. OBERGESCHOSS

Wohnfläche	59,68 m <sup>2</sup>
Balkon	11,38 m <sup>2</sup>
Kellerabteil	Nr. 25
Tiefgaragen-Stellplatz	Nr. 24

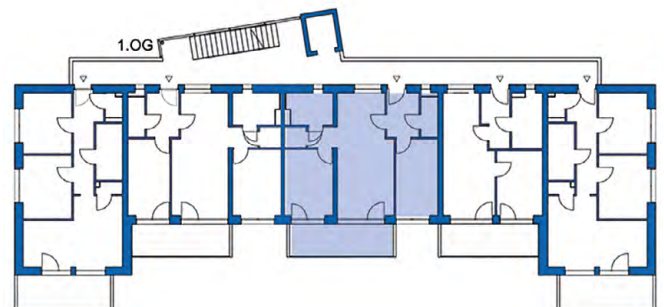

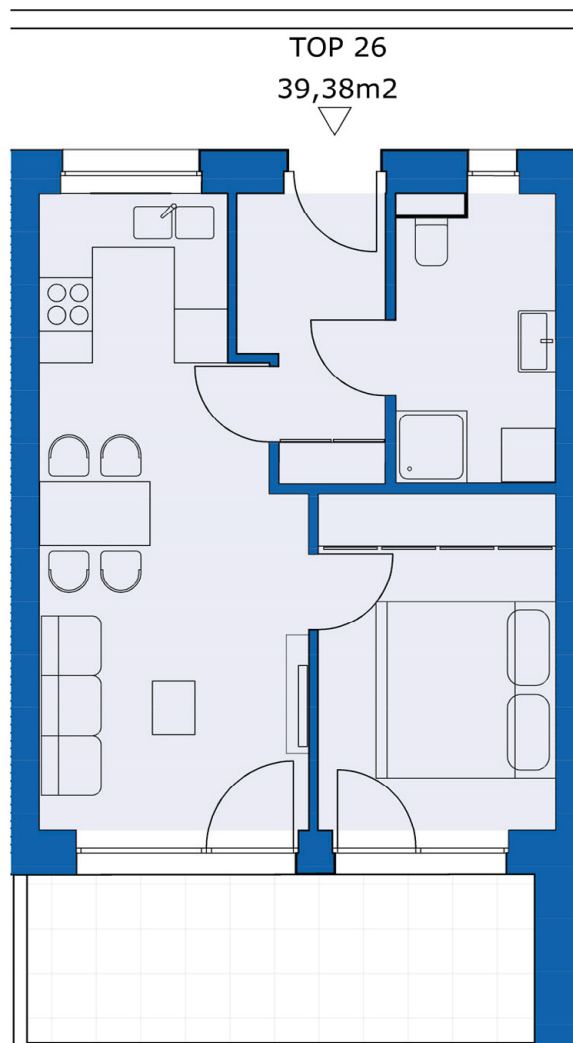

**Tiergartenweg 32d** | 8055 Graz

TOP 26 / 1. OBERGESCHOSS

Wohnfläche	39,38 m <sup>2</sup>
Balkon	10,75 m <sup>2</sup>
Kellerabteil	Nr. 26
Tiefgaragen-Stellplatz	Nr. 25

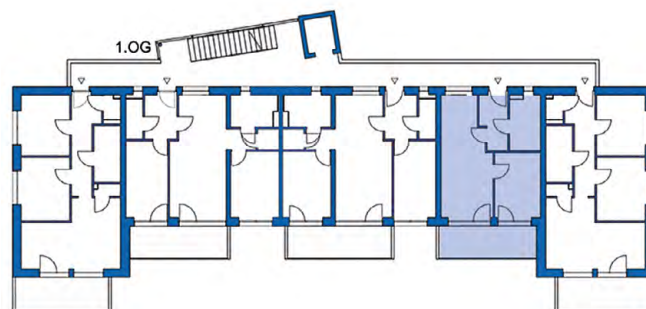

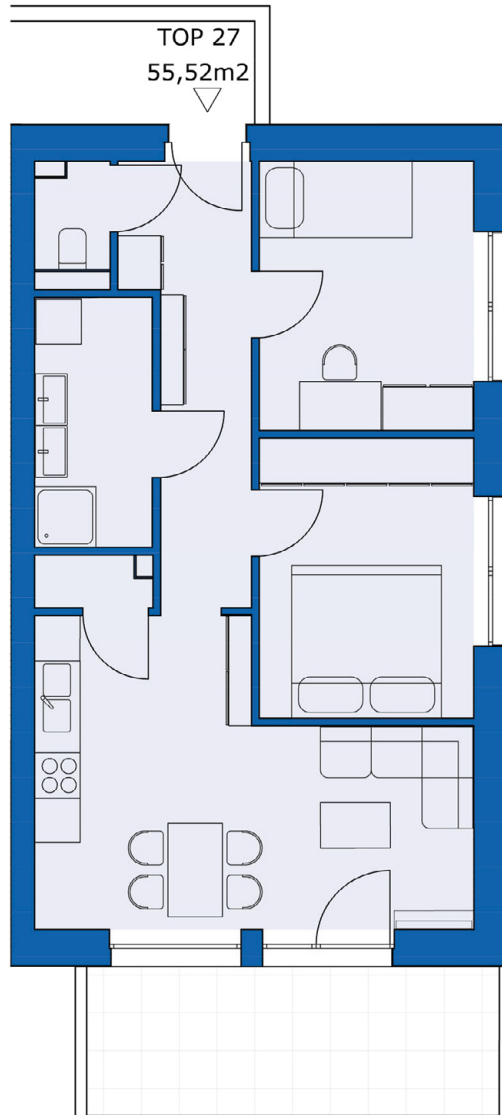

**Tiergartenweg 32d** | 8055 Graz

**TOP 27 / 1. OBERGESCHOSS**

Wohnfläche	55,52 m <sup>2</sup>
Balkon	10,74 m <sup>2</sup>
Kellerabteil	Nr. 27
Tiefgaragen-Stellplatz	Nr. 26

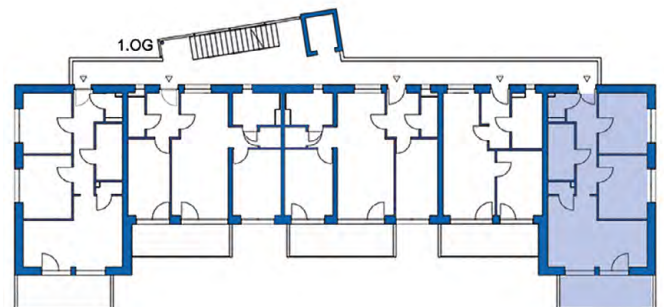

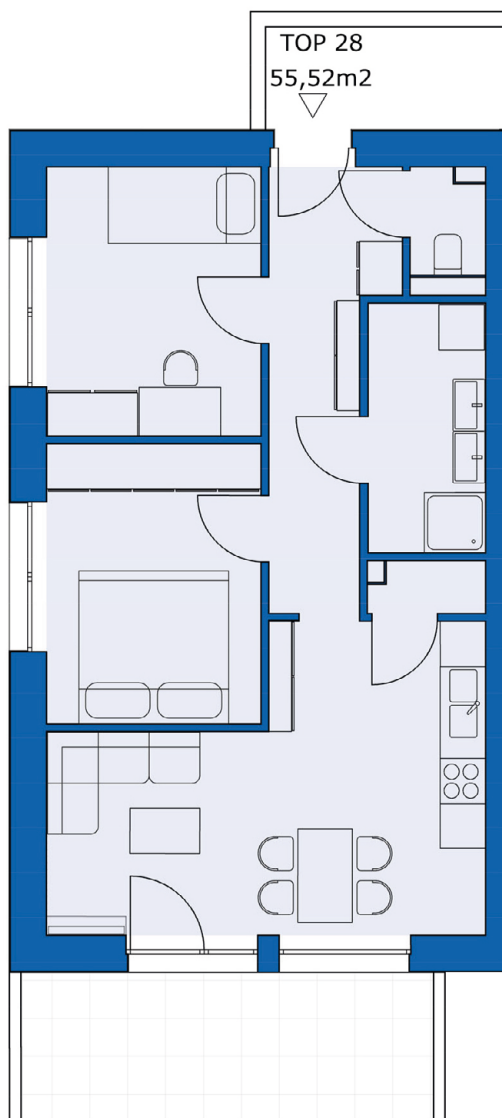

## Tiergartenweg 32d | 8055 Graz

### TOP 28 / 2. OBERGESCHOSS

Wohnfläche	55,52 m <sup>2</sup>
Balkon	10,74 m <sup>2</sup>
Kellerabteil	Nr. 28
Tiefgaragen-Stellplatz	Nr. 27

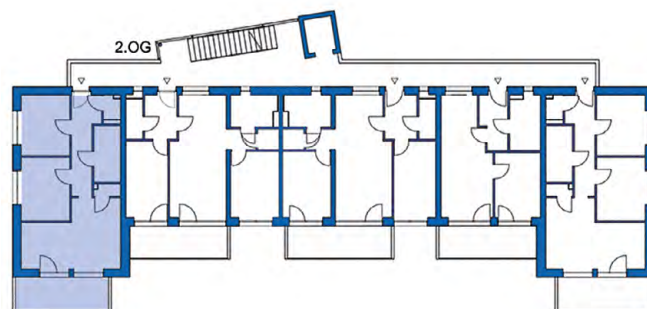

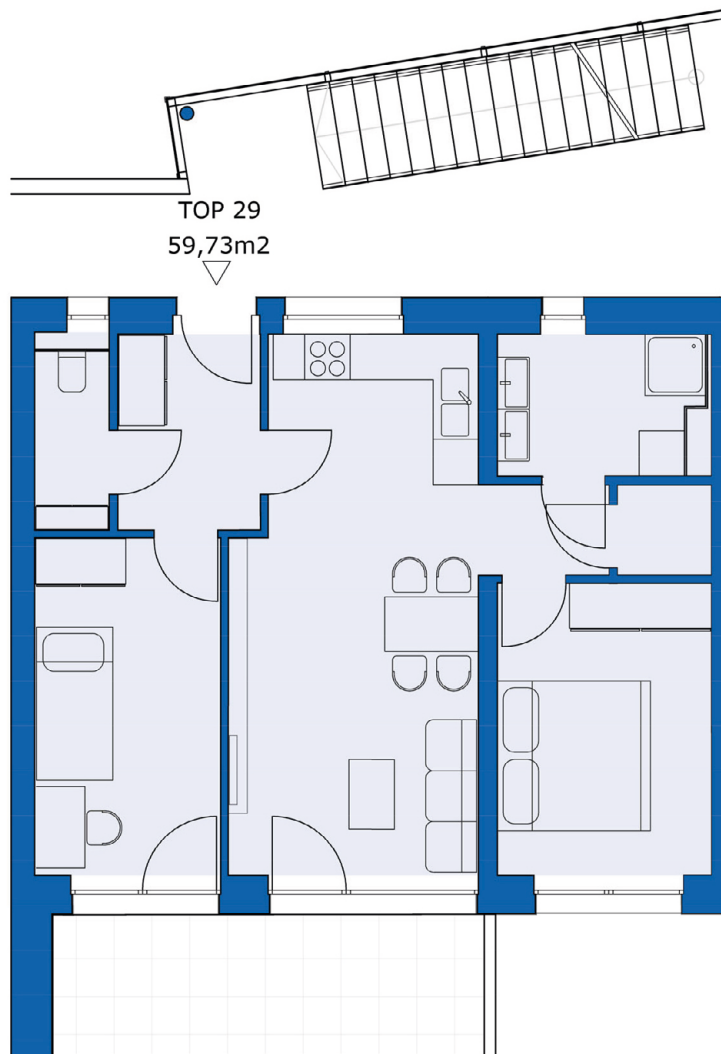

## Tiergartenweg 32d | 8055 Graz

### TOP 29 / 2. OBERGESCHOSS

Wohnfläche	59,73 m <sup>2</sup>
Balkon	10,62 m <sup>2</sup>
Kellerabteil	Nr. 29
Tiefgaragen-Stellplatz	Nr. 28

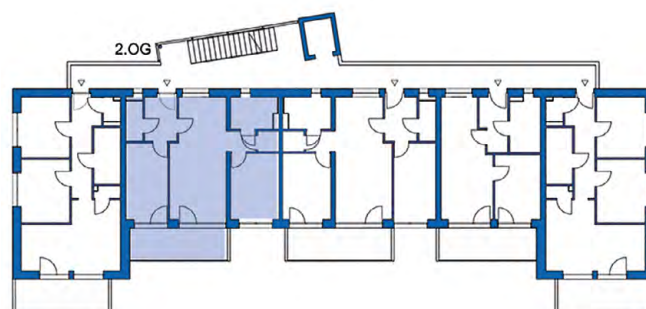

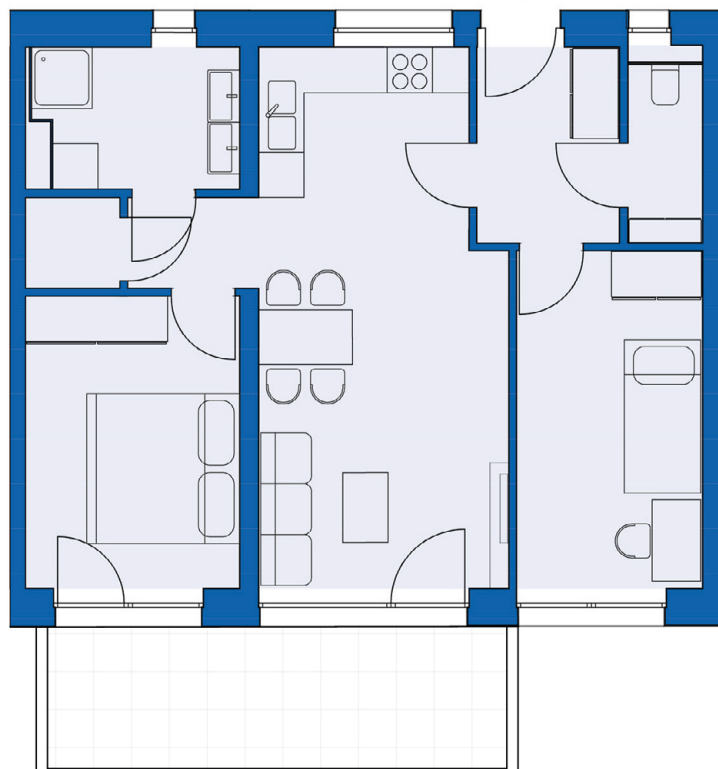
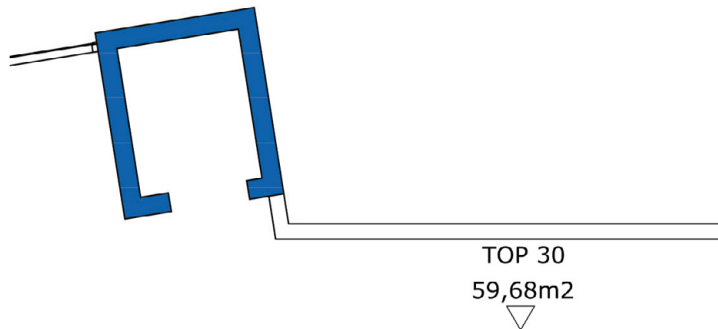

**Tiergartenweg 32d** | 8055 Graz

**TOP 30 / 2. OBERGESCHOSS**

Wohnfläche	59,68 m <sup>2</sup>
Balkon	11,38 m <sup>2</sup>
Kellerabteil	Nr. 30
Tiefgaragen-Stellplatz	Nr. 41

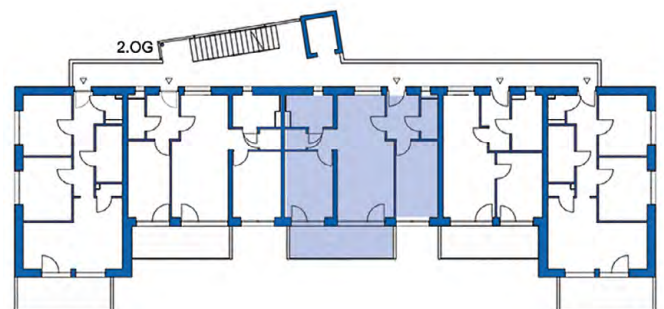

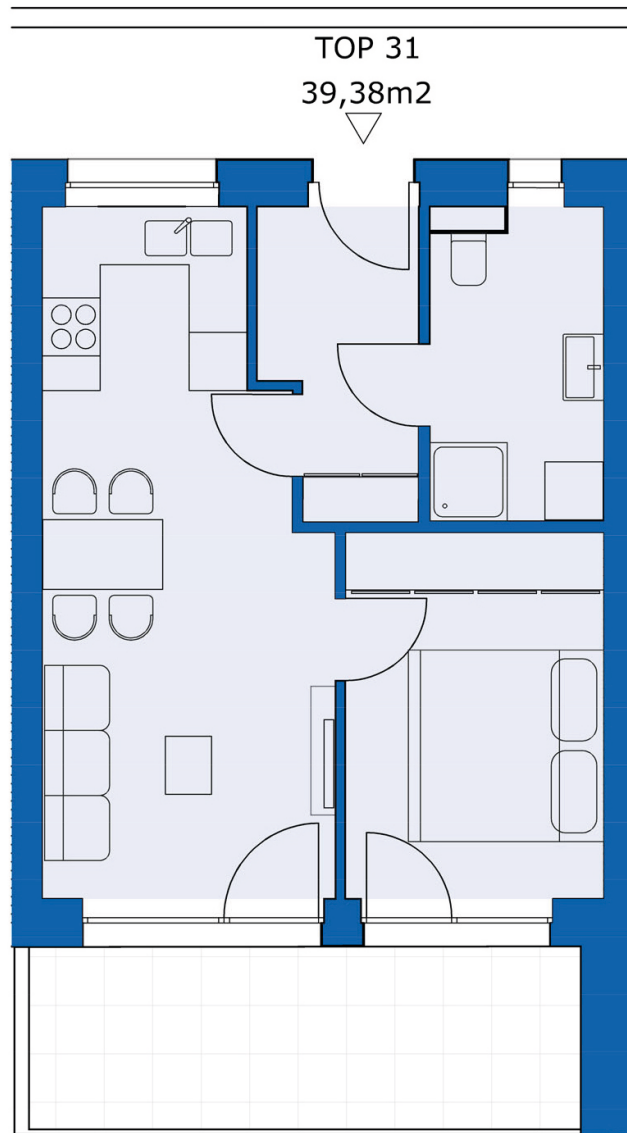

## Tiergartenweg 32d | 8055 Graz

### TOP 31 / 2. OBERGESCHOSS

Wohnfläche	39,38 m <sup>2</sup>
Balkon	10,75 m <sup>2</sup>
Kellerabteil	Nr. 31
Tiefgaragen-Stellplatz	Nr. 40

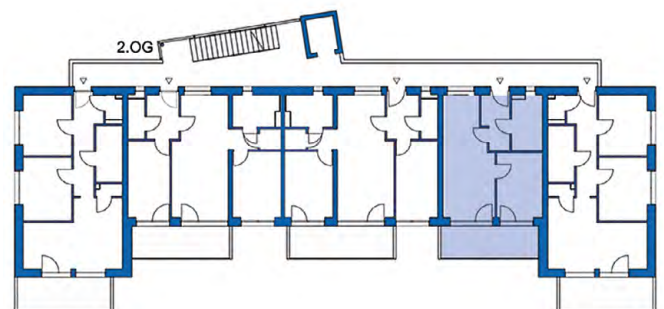



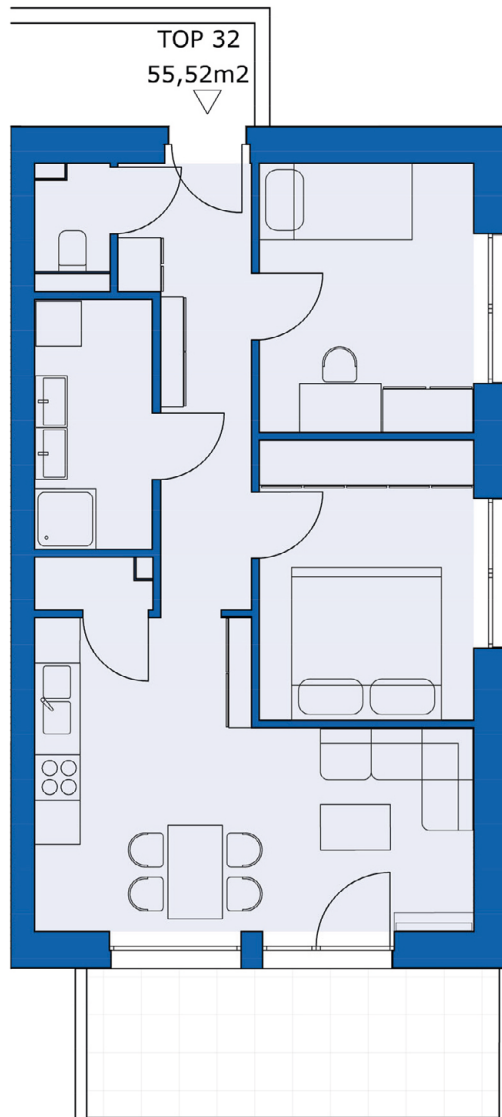

## Tiergartenweg 32d | 8055 Graz

### TOP 32 / 2. OBERGESCHOSS

Wohnfläche	55,52 m <sup>2</sup>
Balkon	10,74 m <sup>2</sup>
Kellerabteil	Nr. 32
Tiefgaragen-Stellplatz	Nr. 39

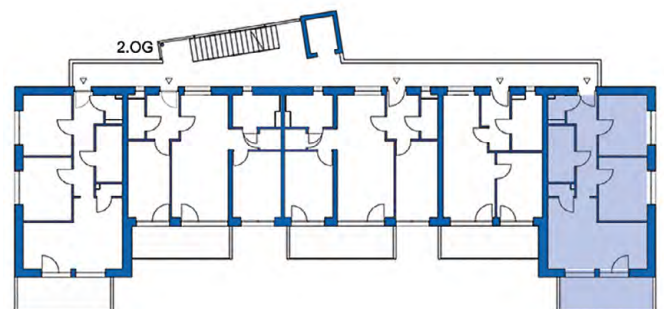

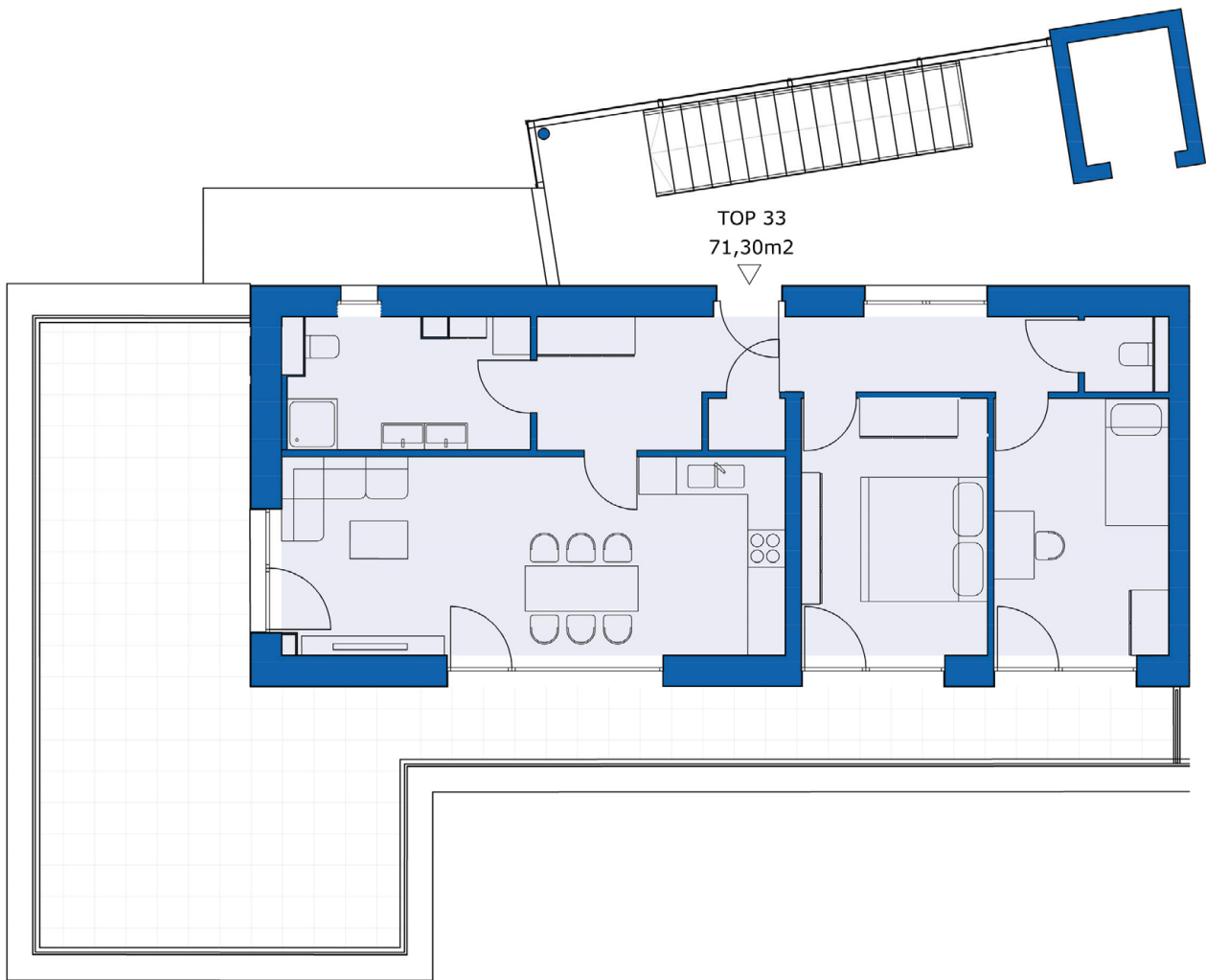

**Tiergartenweg 32d** | 8055 Graz

**TOP 33 / DACHGESCHOSS**

Wohnfläche	71,30 m <sup>2</sup>
Terrasse	58,10 m <sup>2</sup>
Kellerabteil	Nr. 33
Tiefgaragen-Stellplatz	Nr. 37 und 38

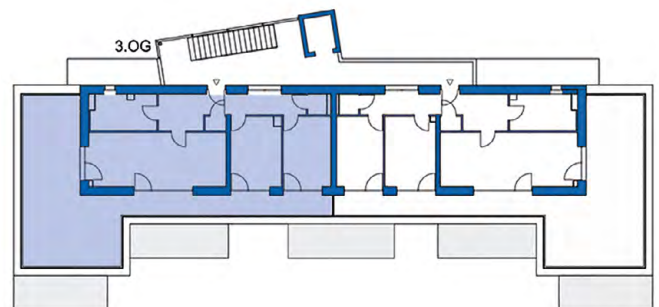

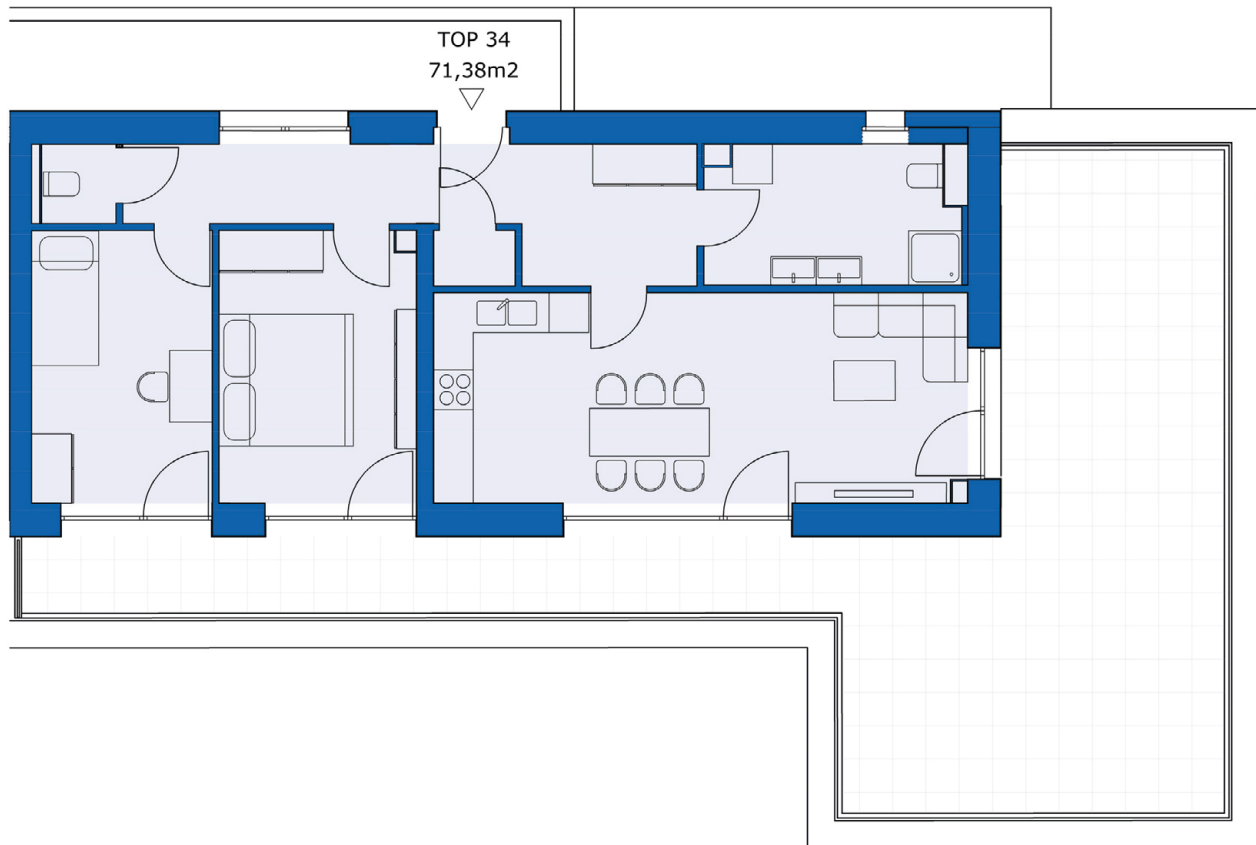

**Tiergartenweg 32d** | 8055 Graz

**TOP 34 / DACHGESCHOSS**

Wohnfläche	71,38 m <sup>2</sup>
Terrasse	58,10 m <sup>2</sup>
Kellerabteil	Nr. 34
Tiefgaragen-Stellplatz	Nr. 35 und 36

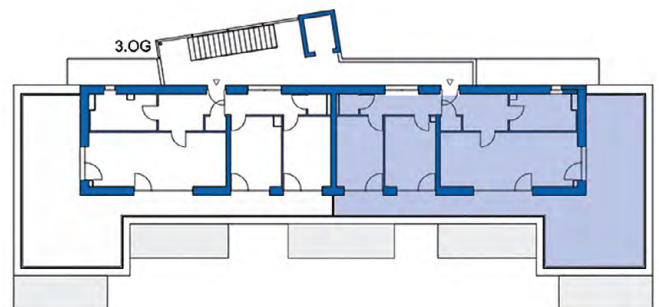

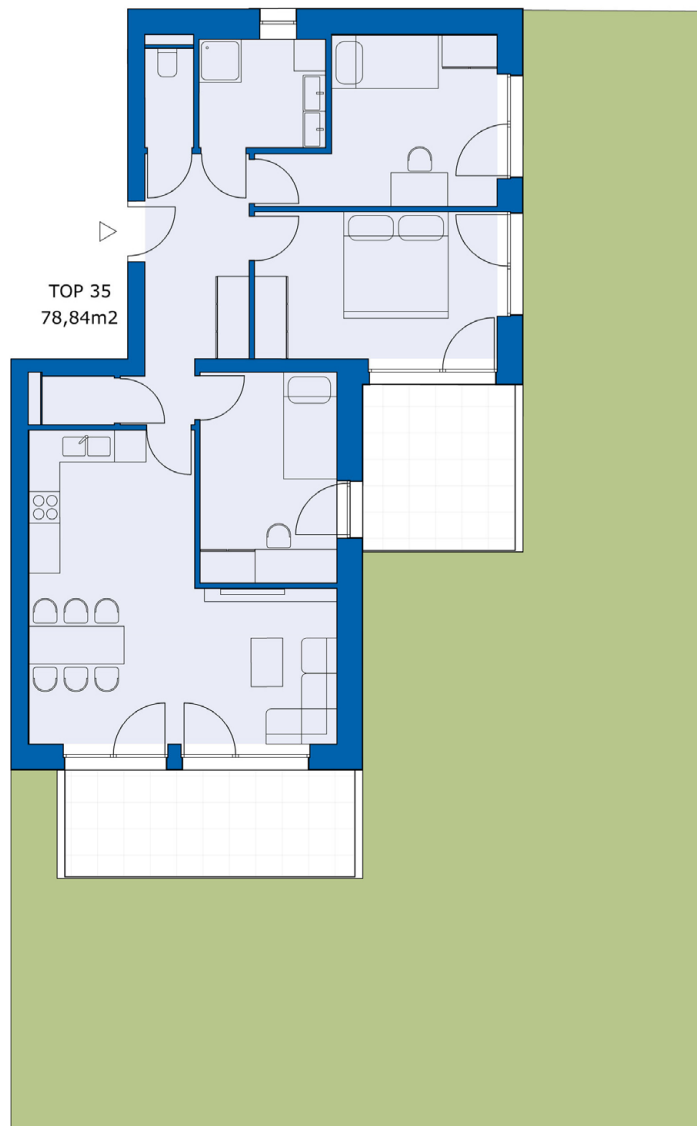

## Tiergartenweg 32c | 8055 Graz

### TOP 35 / ERDGESCHOSS

Wohnfläche	78,84 m <sup>2</sup>
Garten	138,06 m <sup>2</sup>
Terrasse	20,09 m <sup>2</sup>
Kellerabteil	Nr. 35
Tiefgaragen-Stellplatz	Nr. 49

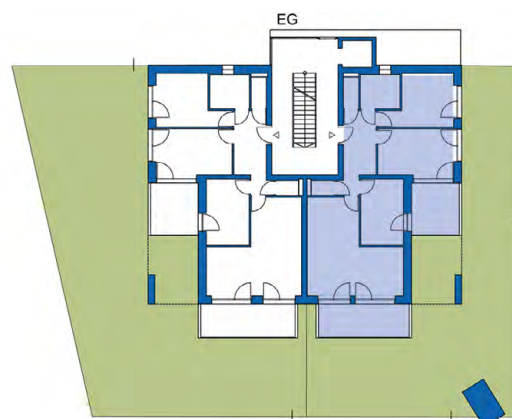



**Tiergartenweg 32c** | 8055 Graz

**TOP 36 / ERDGESCHOSS**

Wohnfläche	78,39 m <sup>2</sup>
Garten	191,19 m <sup>2</sup>
Terrasse	20,13 m <sup>2</sup>
Kellerabteil	Nr. 36
Tiefgaragen-Stellplatz	Nr. 50

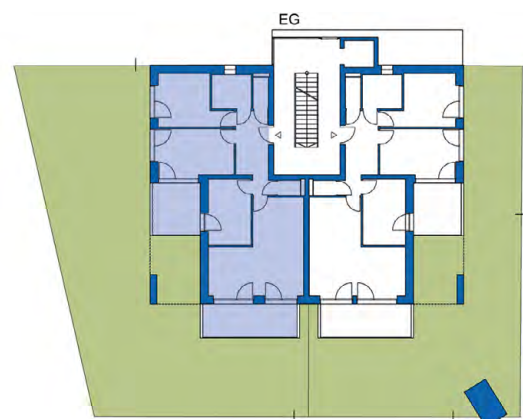

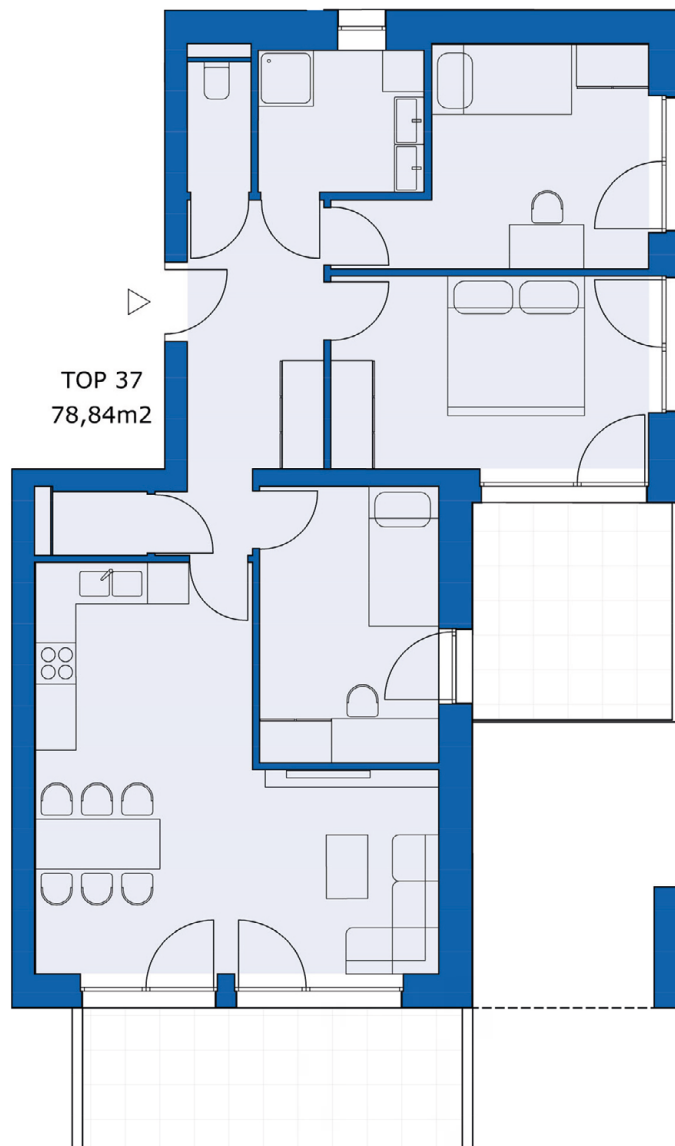

**Tiergartenweg 32c** | 8055 Graz

TOP 37 / 1. OBERGESCHOSS

Wohnfläche	78,84 m <sup>2</sup>
Balkon	20,09 m <sup>2</sup>
Kellerabteil	Nr. 37
Tiefgaragen-Stellplatz	Nr. 51

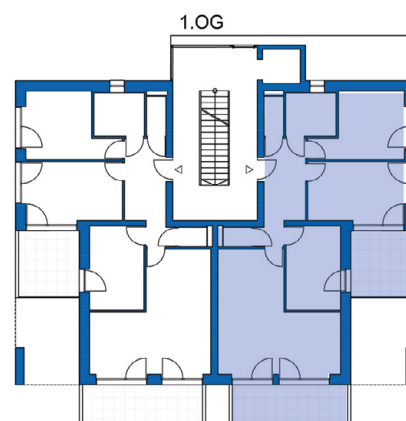

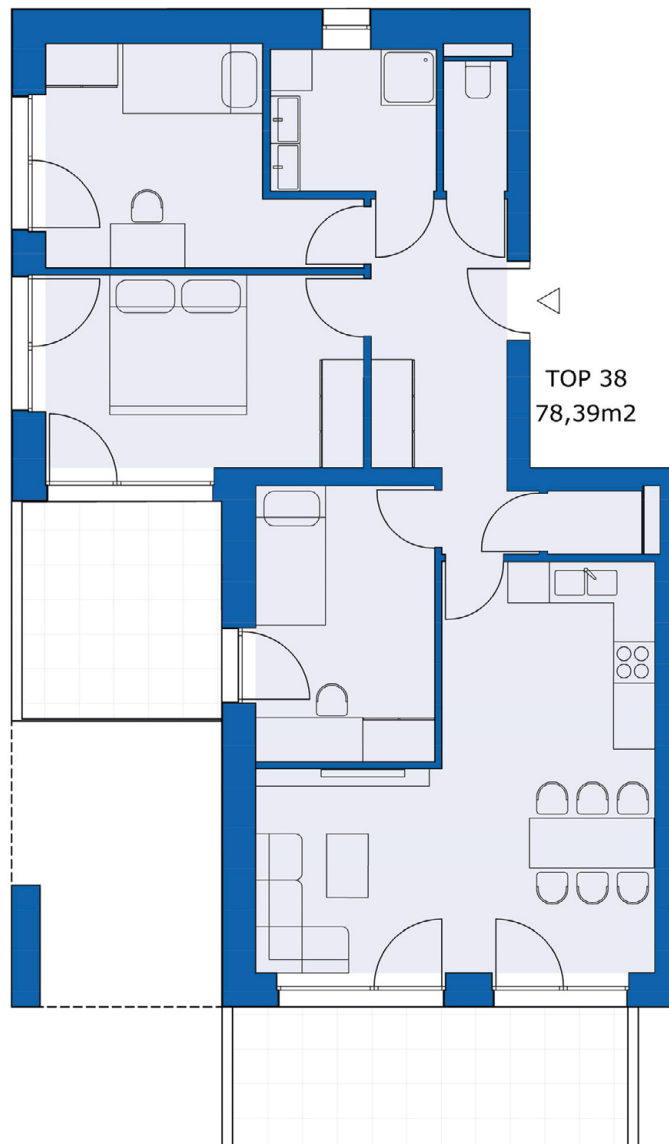

TOP 38  
78,39m<sup>2</sup>



## Tiergartenweg 32c | 8055 Graz

### TOP 38 / 1. OBERGESCHOSS

Wohnfläche	78,39 m <sup>2</sup>
Balkon	20,13 m <sup>2</sup>
Kellerabteil	Nr. 38
Tiefgaragen-Stellplatz	Nr. 52

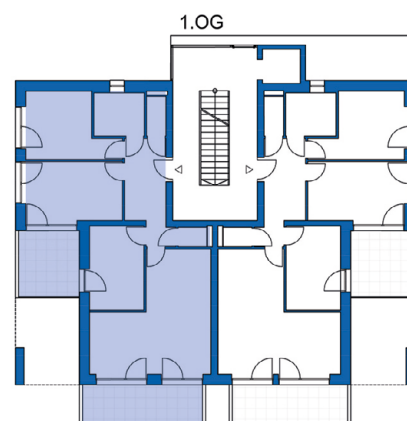

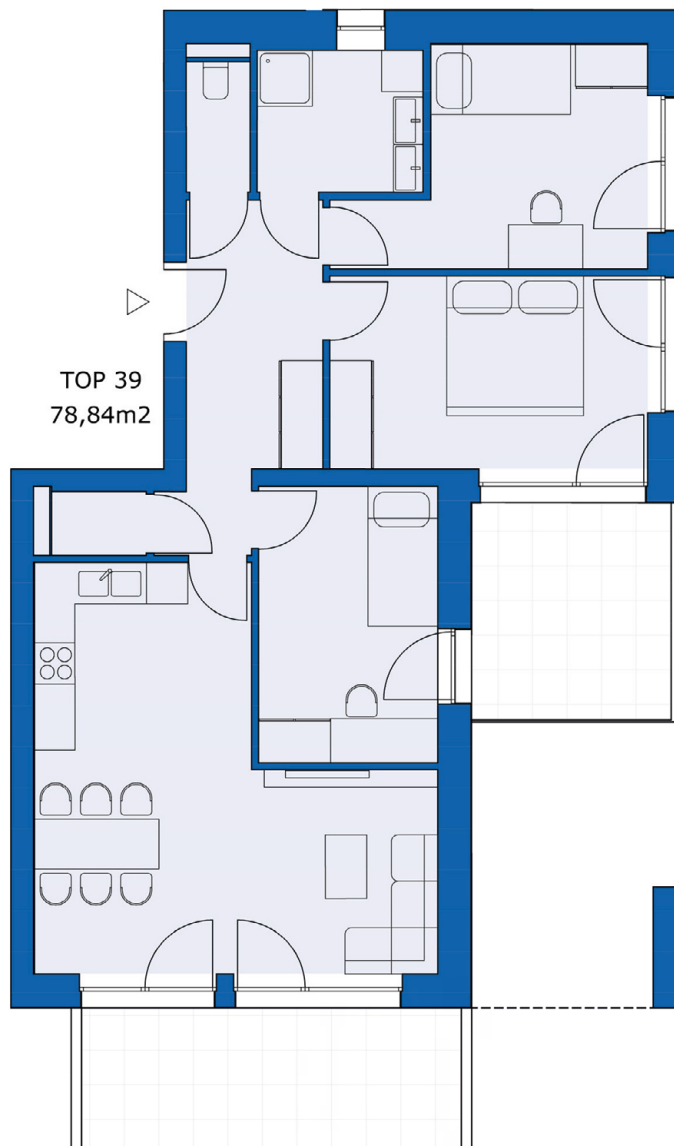

**Tiergartenweg 32c** | 8055 Graz

**TOP 39 / 2. OBERGESCHOSS**

Wohnfläche	78,84 m <sup>2</sup>
Balkon	20,09 m <sup>2</sup>
Kellerabteil	Nr. 39
Tiefgaragen-Stellplatz	Nr. 62

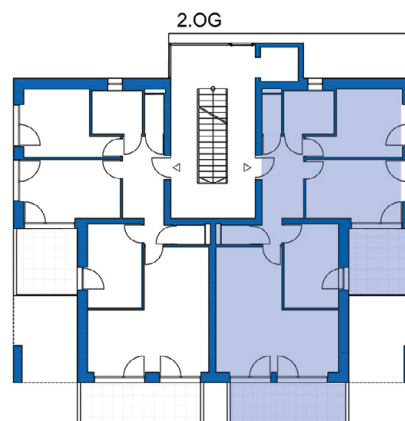



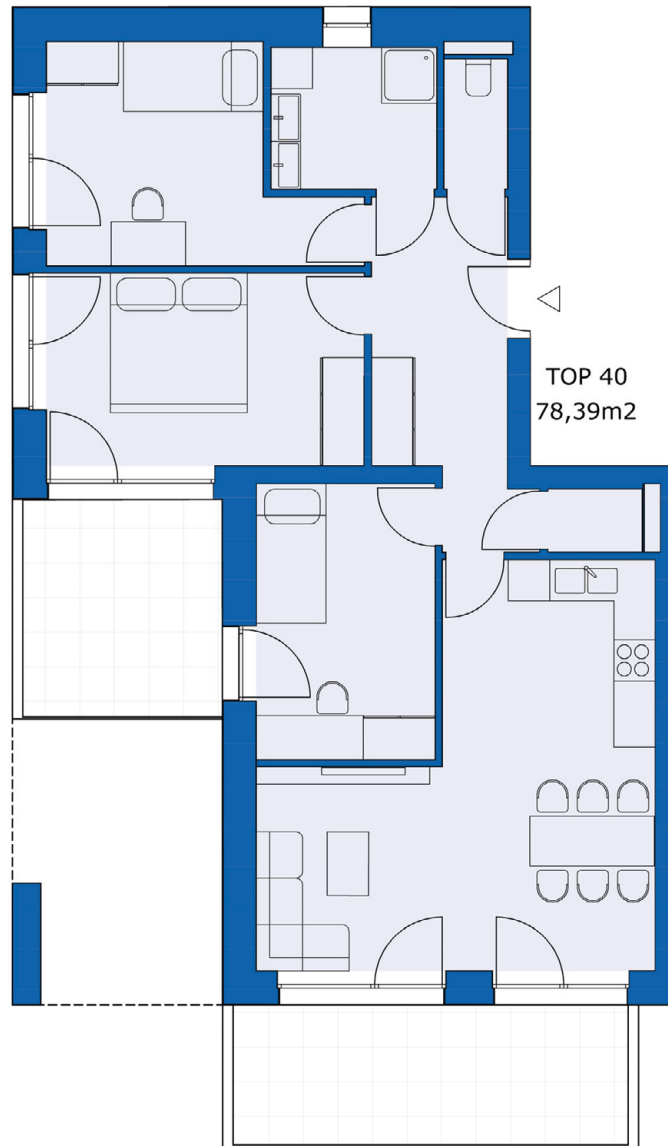

TOP 40  
78,39m<sup>2</sup>



**Tiergartenweg 32c** | 8055 Graz

TOP 40 / 2. OBERGESCHOSS

Wohnfläche	78,39 m <sup>2</sup>
Balkon	20,13 m <sup>2</sup>
Kellerabteil	Nr. 40
Tiefgaragen-Stellplatz	Nr. 61

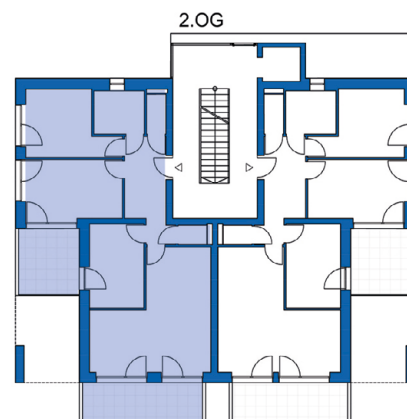

TOP 41  
68,20m<sup>2</sup>

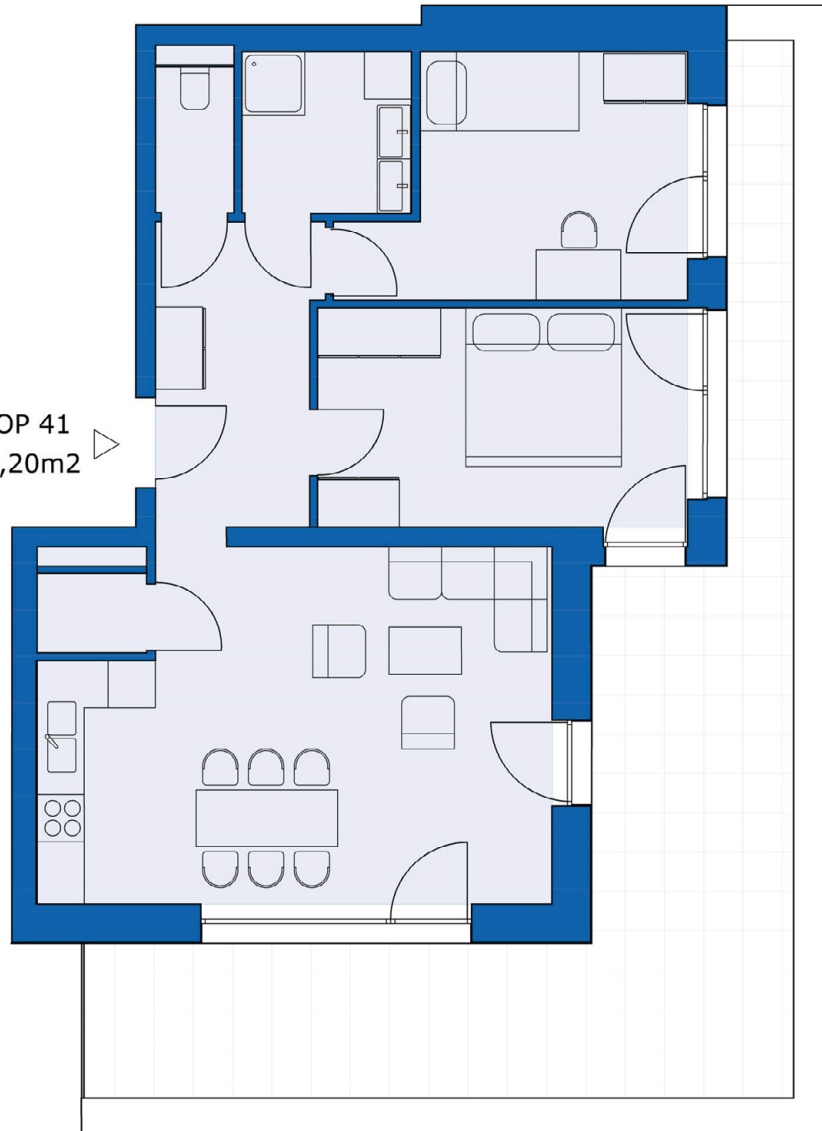

## Tiergartenweg 32c | 8055 Graz

### TOP 41 / DACHGESCHOSS

Wohnfläche	68,20 m <sup>2</sup>
Terrasse	34,62 m <sup>2</sup>
Kellerabteil	Nr. 41
Tiefgaragen-Stellplatz	Nr. 60

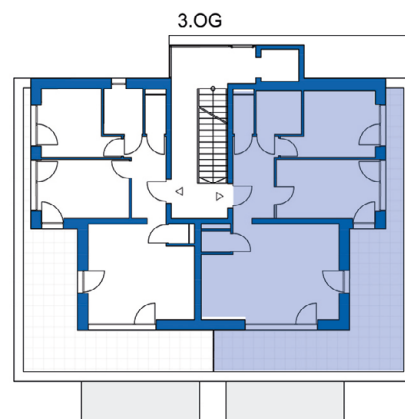

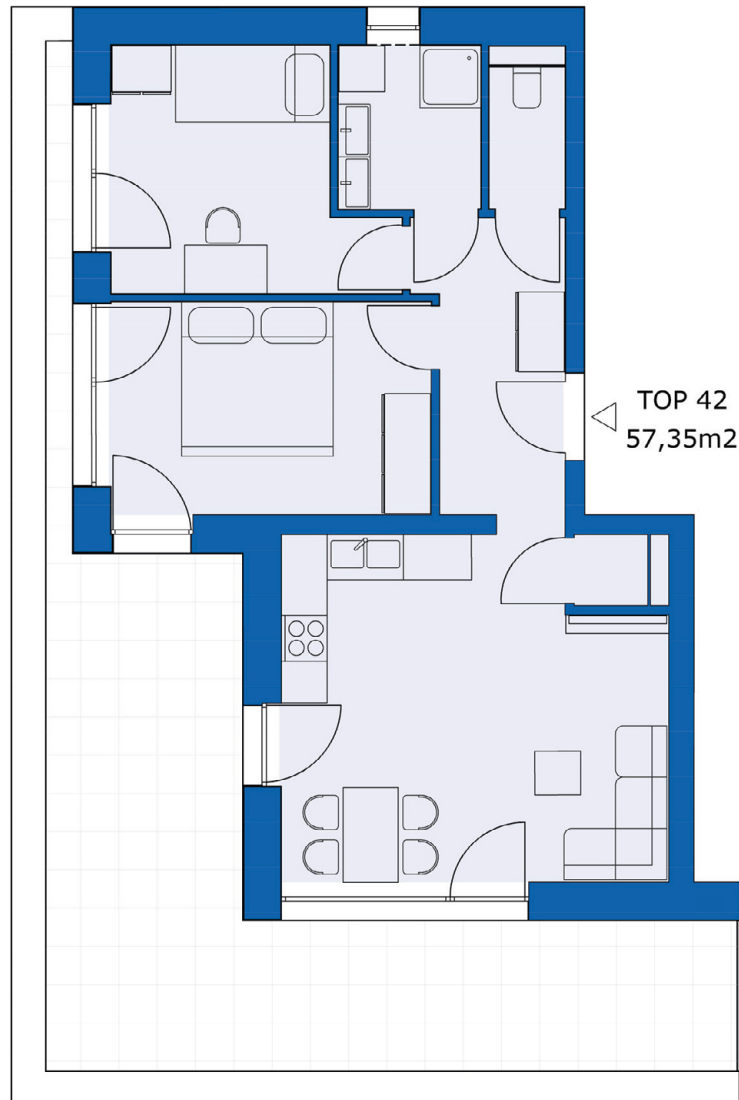

**Tiergartenweg 32c** | 8055 Graz

**TOP 42 / DACHGESCHOSS**

Wohnfläche	57,35 m <sup>2</sup>
Terrasse	32,16 m <sup>2</sup>
Kellerabteil	Nr. 42
Tiefgaragen-Stellplatz	Nr. 59

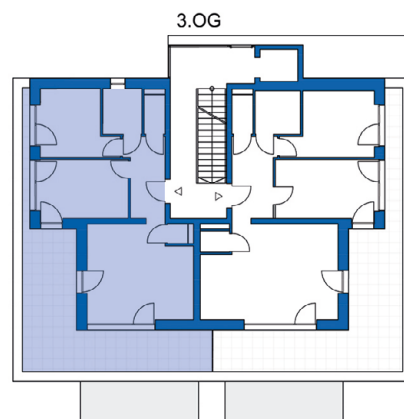

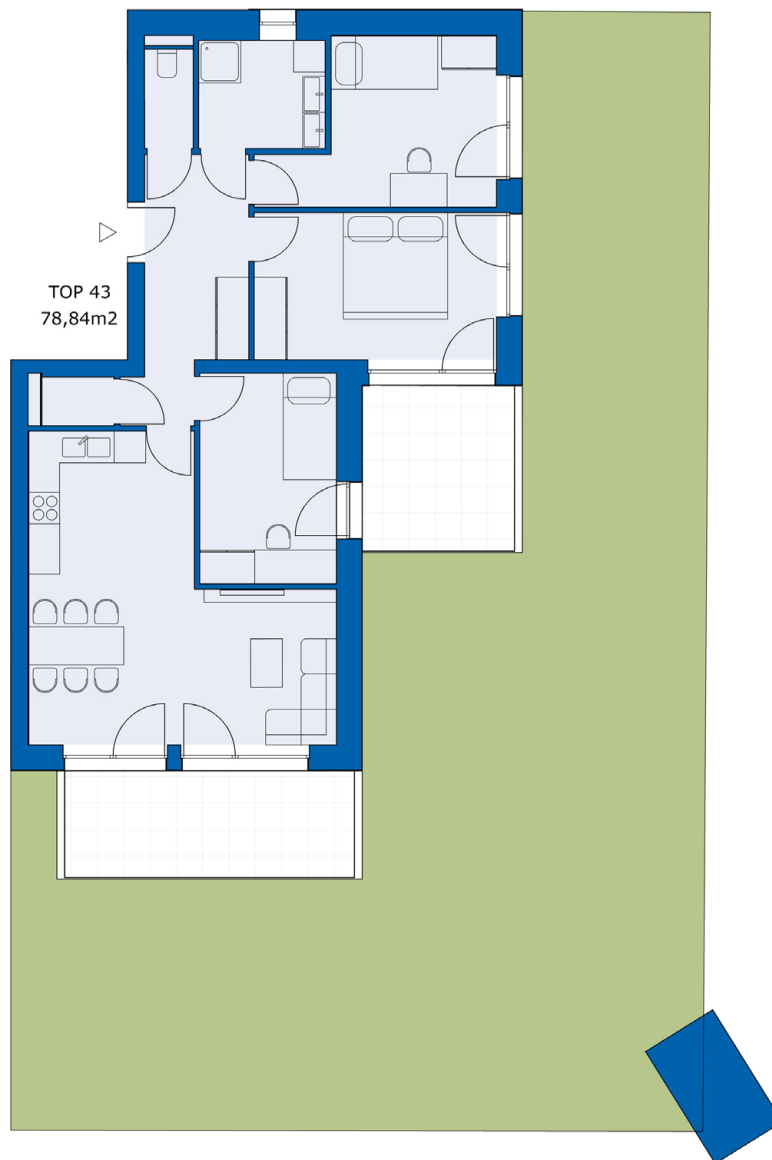

**Tiergartenweg 32b** | 8055 Graz

**TOP 43 / ERDGESCHOSS**

Wohnfläche	78,84 m <sup>2</sup>
Garten	135,20 m <sup>2</sup>
Terrasse	20,09 m <sup>2</sup>
Kellerabteil	Nr. 43
Tiefgaragen-Stellplatz	Nr. 53

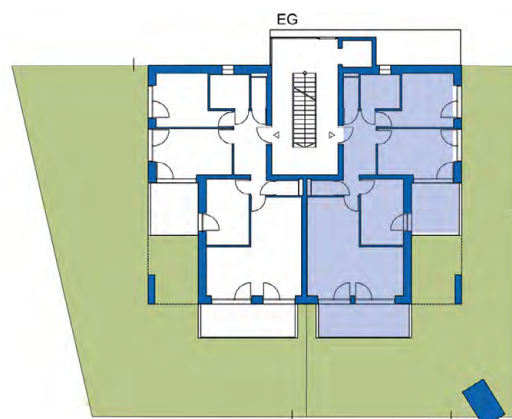



**Tiergartenweg 32b** | 8055 Graz

**TOP 44 / ERDGESCHOSS**

Wohnfläche	78,39 m <sup>2</sup>
Garten	192,00 m <sup>2</sup>
Terrasse	20,13 m <sup>2</sup>
Kellerabteil	Nr. 44
Tiefgaragen-Stellplatz	Nr. 54

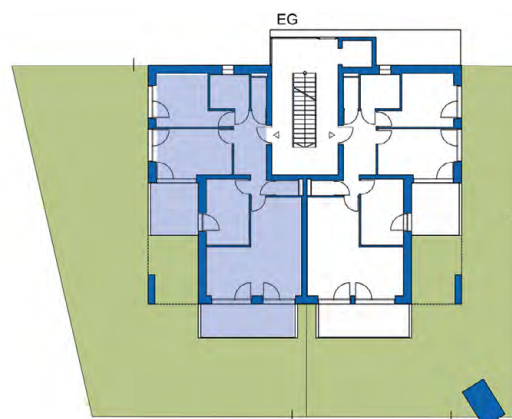

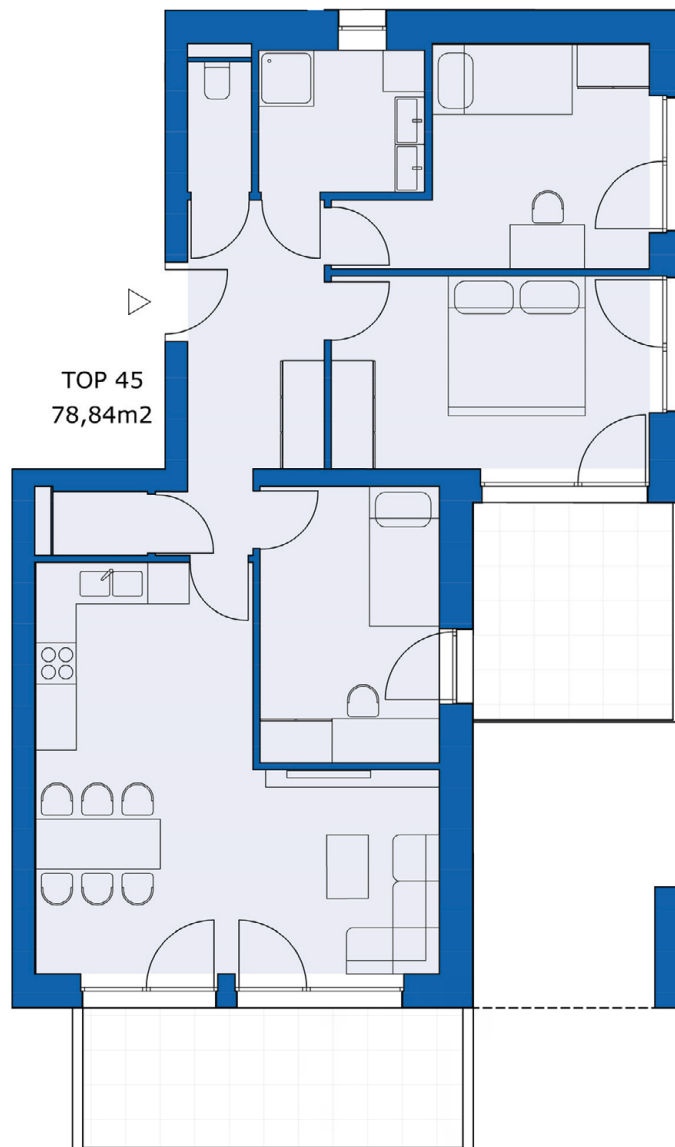

**Tiergartenweg 32b** | 8055 Graz

**TOP 45 / 1. OBERGESCHOSS**

Wohnfläche	78,84 m <sup>2</sup>
Balkon	20,09 m <sup>2</sup>
Kellerabteil	Nr. 45
Tiefgaragen-Stellplatz	Nr. 55

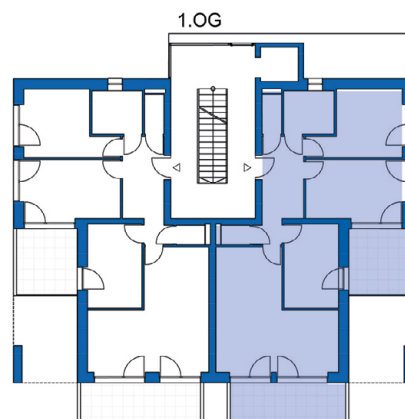

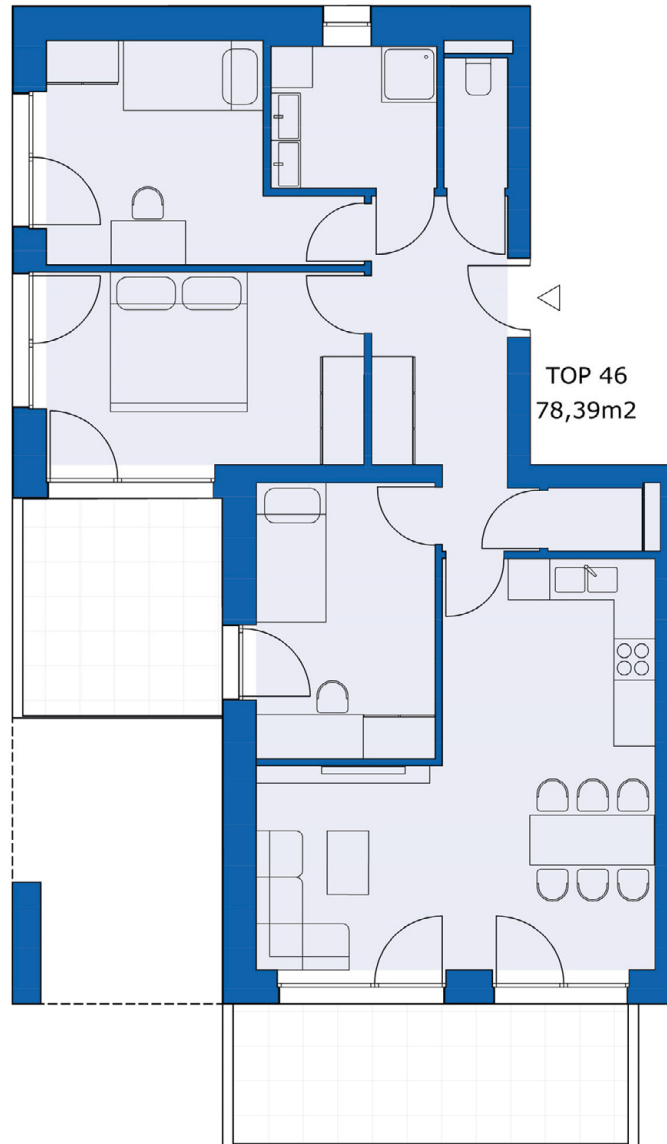

**Tiergartenweg 32b** | 8055 Graz

**TOP 46 / 1. OBERGESCHOSS**

Wohnfläche	78,39 m <sup>2</sup>
Balkon	20,13 m <sup>2</sup>
Kellerabteil	Nr. 46
Tiefgaragen-Stellplatz	Nr. 56

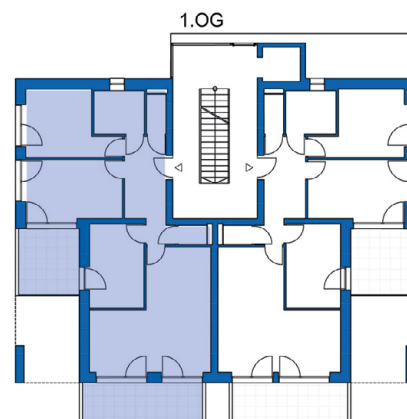

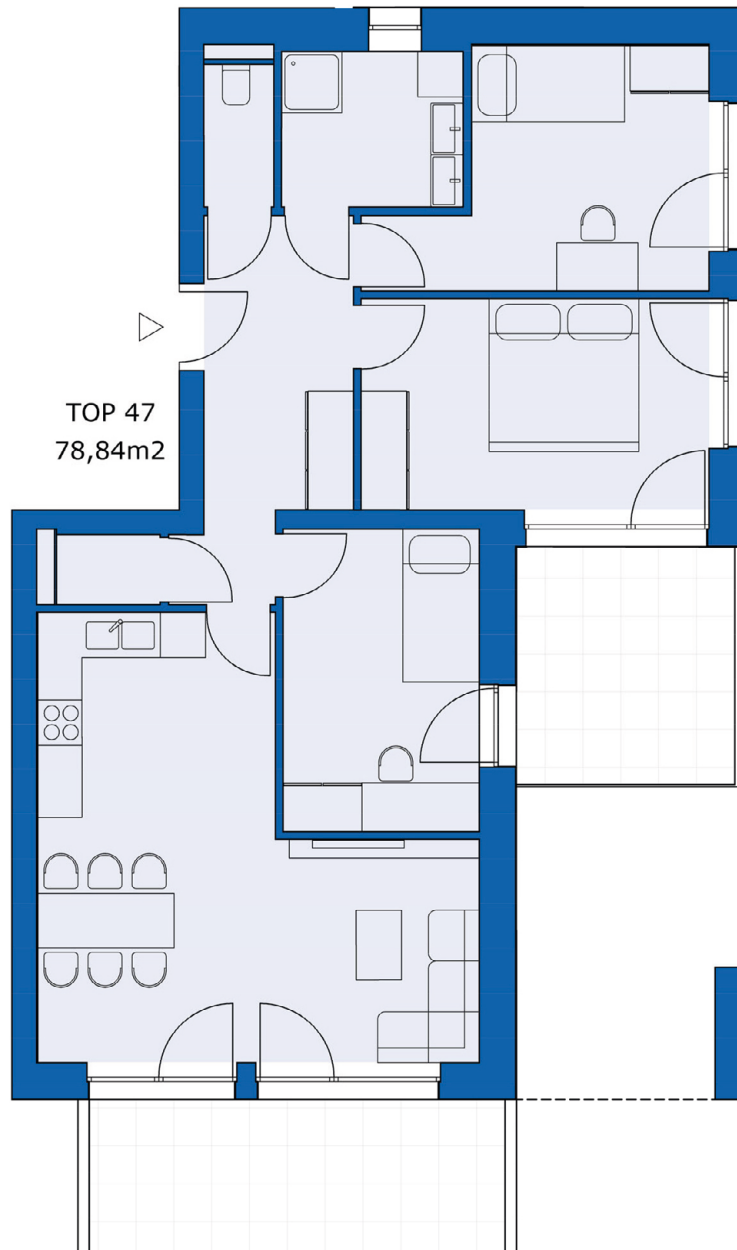

**Tiergartenweg 32b** | 8055 Graz

**TOP 47 / 2. OBERGESCHOSS**

Wohnfläche	78,84 m <sup>2</sup>
Balkon	20,09 m <sup>2</sup>
Kellerabteil	Nr. 47
Tiefgaragen-Stellplatz	Nr. 57

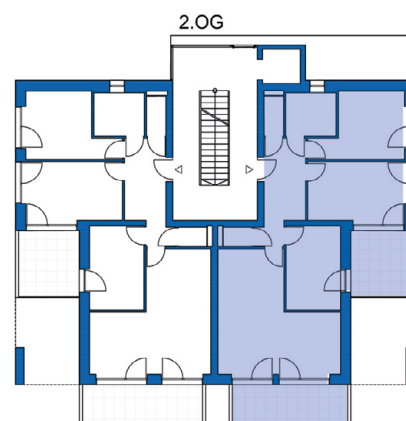



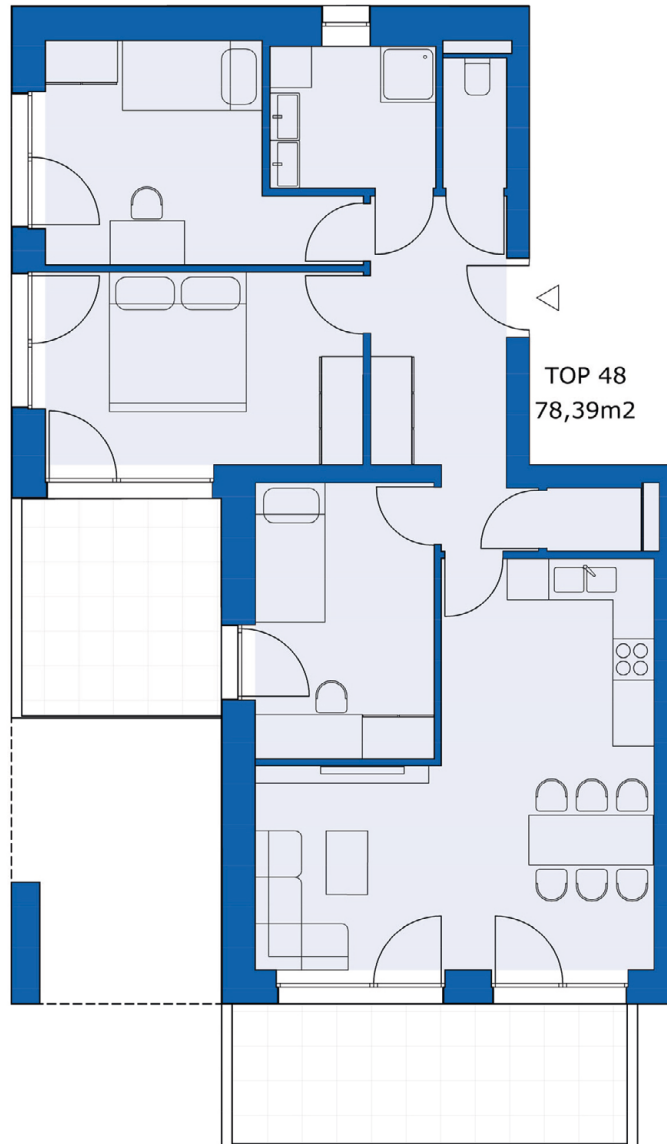

**Tiergartenweg 32b** | 8055 Graz

**TOP 48 / 2. OBERGESCHOSS**

Wohnfläche	78,39 m <sup>2</sup>
Balkon	20,13 m <sup>2</sup>
Kellerabteil	Nr. 48
Tiefgaragen-Stellplatz	Nr. 58

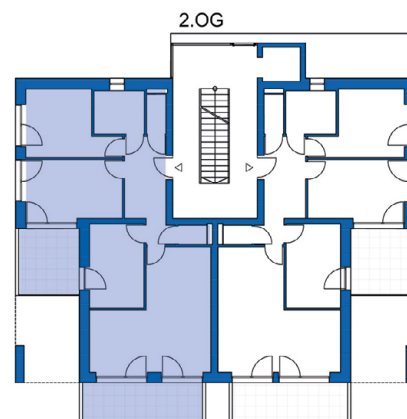

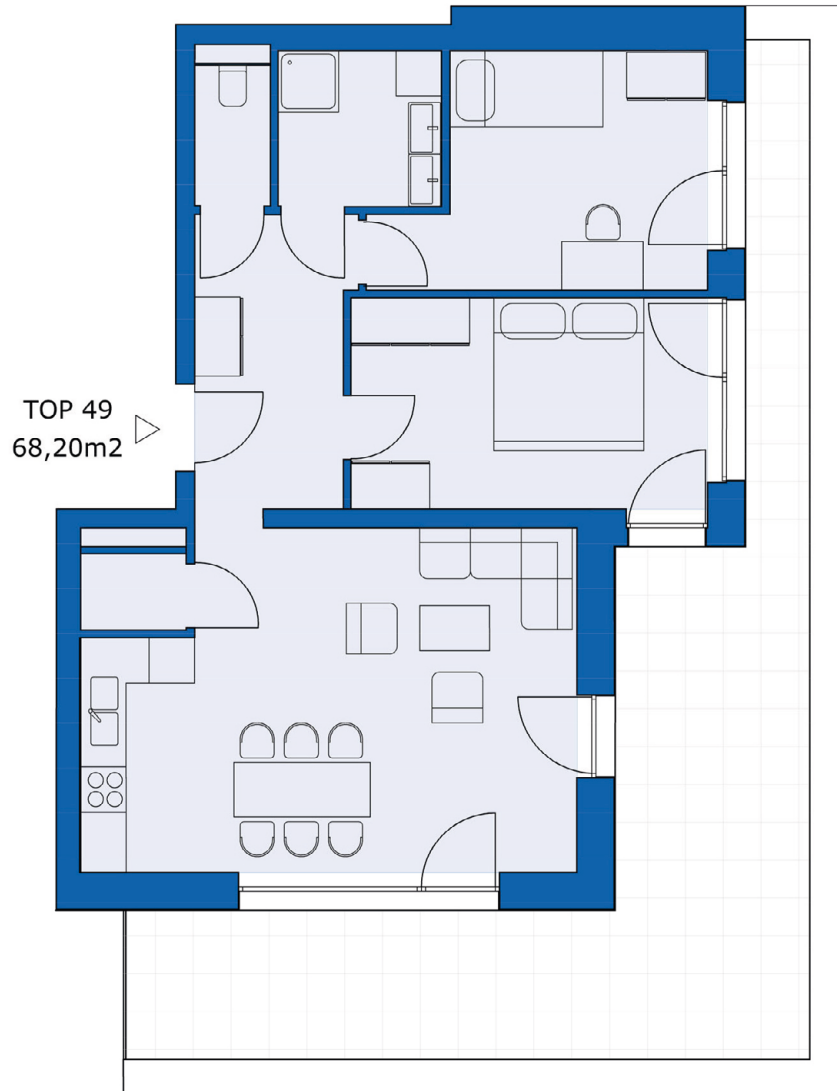

**Tiergartenweg 32b** | 8055 Graz

**TOP 49 / DACHGESCHOSS**

Wohnfläche	68,20 m <sup>2</sup>
Terrasse	34,62 m <sup>2</sup>
Kellerabteil	Nr. 49
Tiefgaragen-Stellplatz	Nr. 48

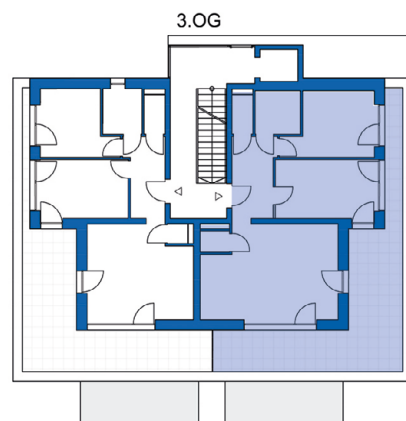

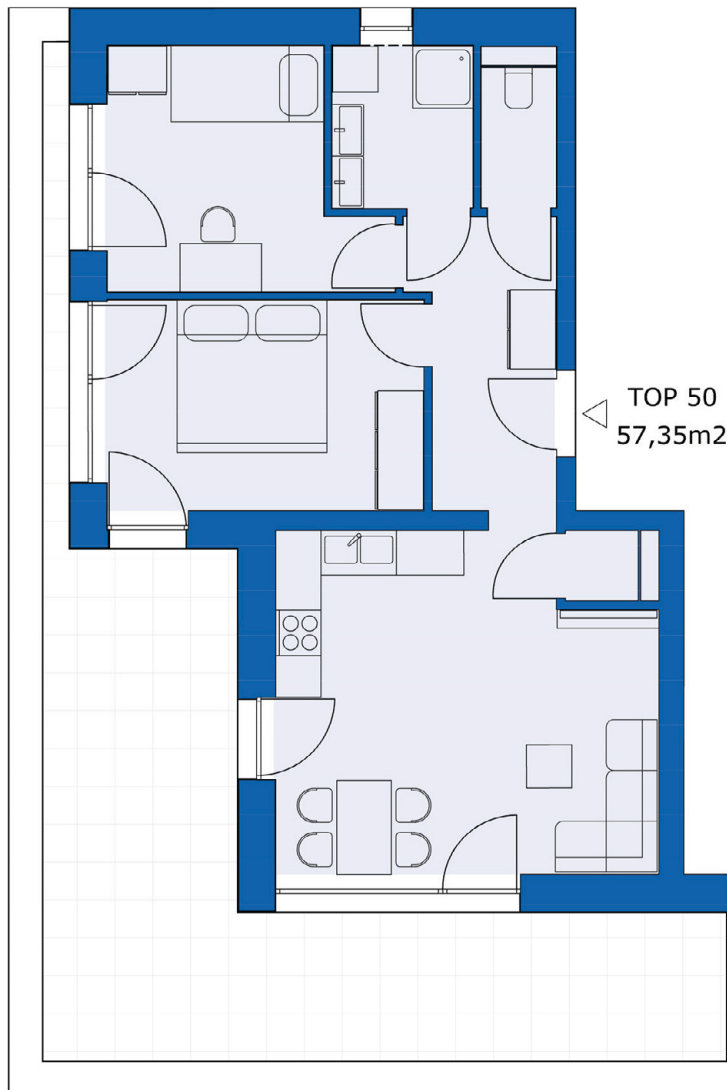

**Tiergartenweg 32b** | 8055 Graz

**TOP 50 / DACHGESCHOSS**

Wohnfläche	57,35 m <sup>2</sup>
Terrasse	32,16 m <sup>2</sup>
Kellerabteil	Nr. 50
Tiefgaragen-Stellplatz	Nr. 47

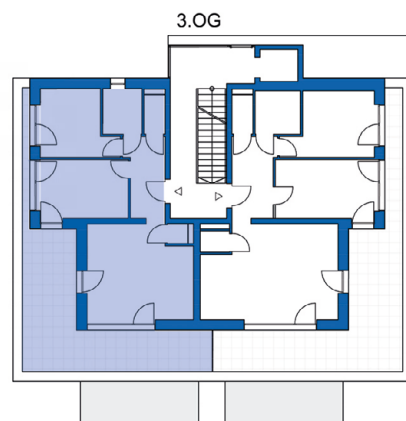

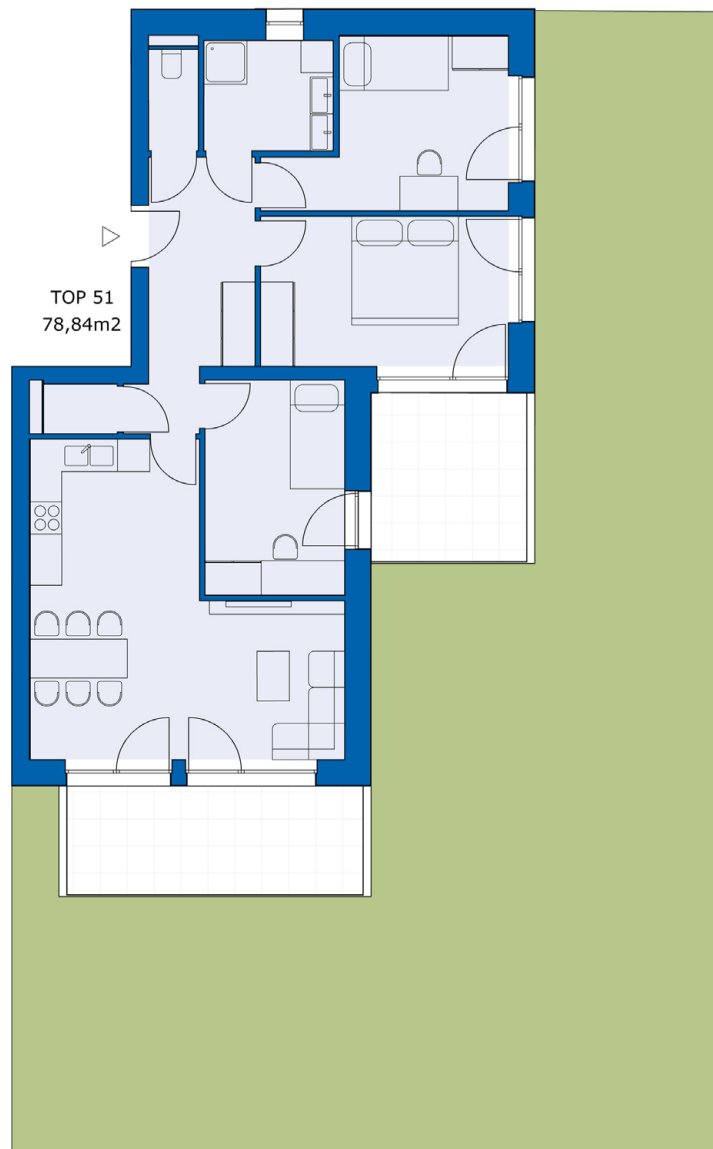

## Tiergartenweg 32a | 8055 Graz

### TOP 51 / ERDGESCHOSS

Wohnfläche	78,84 m <sup>2</sup>
Garten	138,00 m <sup>2</sup>
Terrasse	20,09 m <sup>2</sup>
Kellerabteil	Nr. 51
Tiefgaragen-Stellplatz	Nr. 01

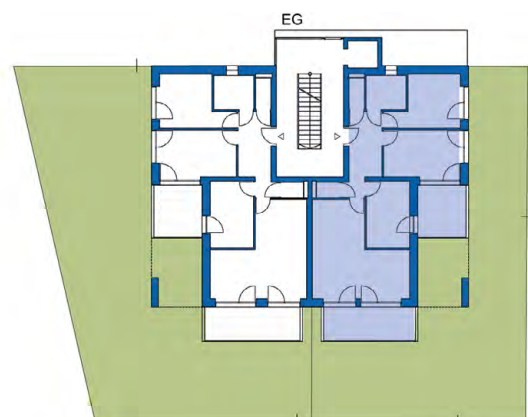



**Tiergartenweg 32a** | 8055 Graz

**TOP 52 / ERDGESCHOSS**

Wohnfläche	78,39 m <sup>2</sup>
Garten	194,36 m <sup>2</sup>
Terrasse	20,13 m <sup>2</sup>
Kellerabteil	Nr. 52
Tiefgaragen-Stellplatz	Nr. 02

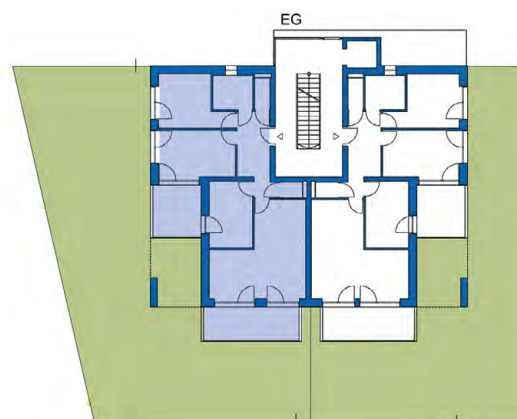

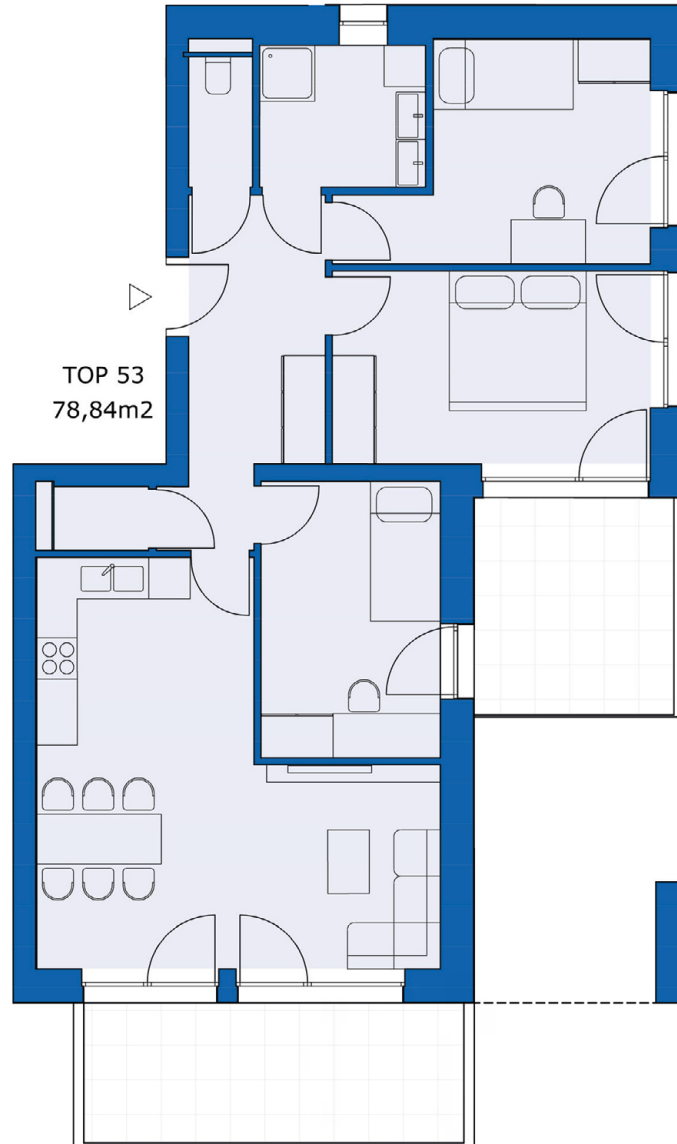

**Tiergartenweg 32a** | 8055 Graz

**TOP 53 / 1. OBERGESCHOSS**

Wohnfläche	78,84 m <sup>2</sup>
Balkon	20,09 m <sup>2</sup>
Kellerabteil	Nr. 53
Tiefgaragen-Stellplatz	Nr. 03

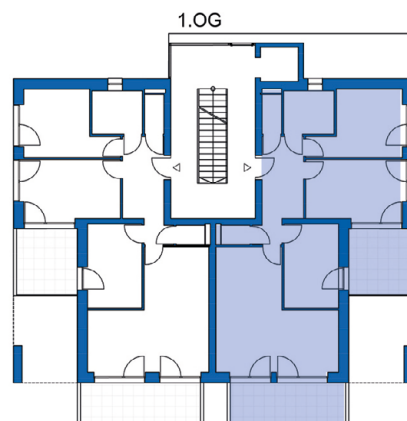

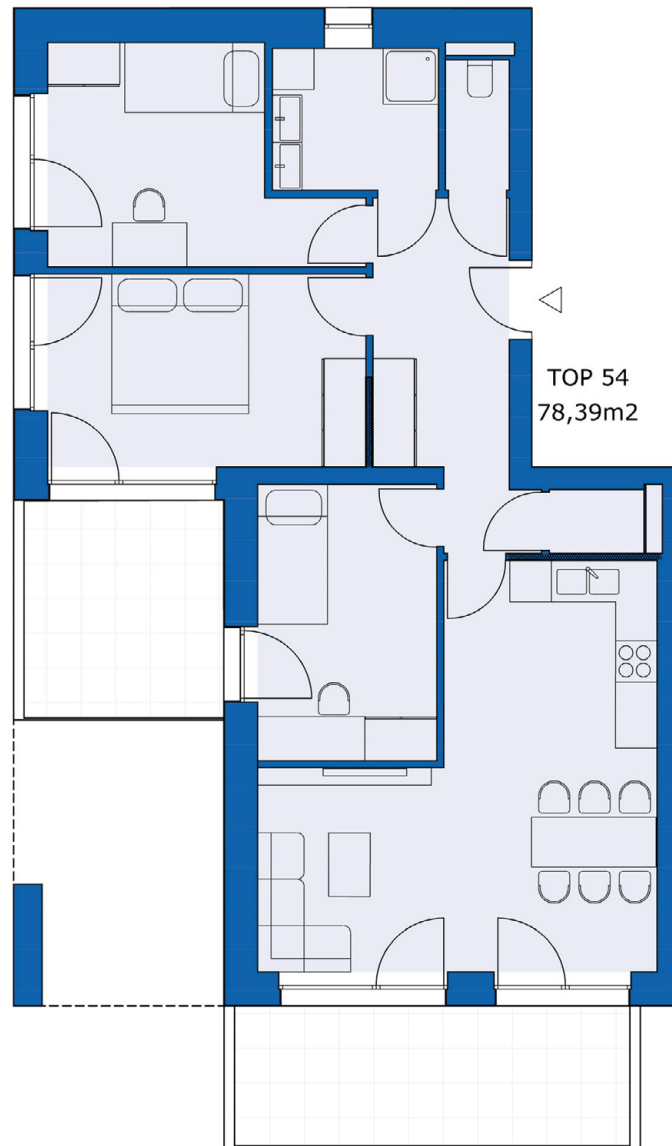

**Tiergartenweg 32a** | 8055 Graz

**TOP 54 / 1. OBERGESCHOSS**

Wohnfläche	78,39 m <sup>2</sup>
Balkon	20,13 m <sup>2</sup>
Kellerabteil	Nr. 54
Tiefgaragen-Stellplatz	Nr. 04

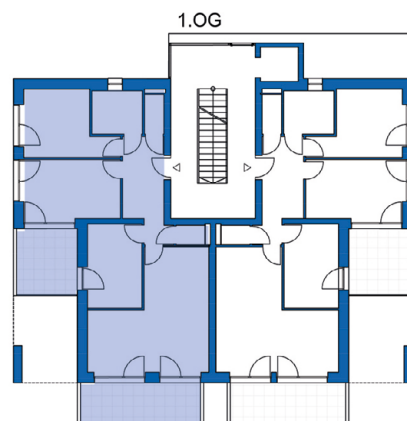

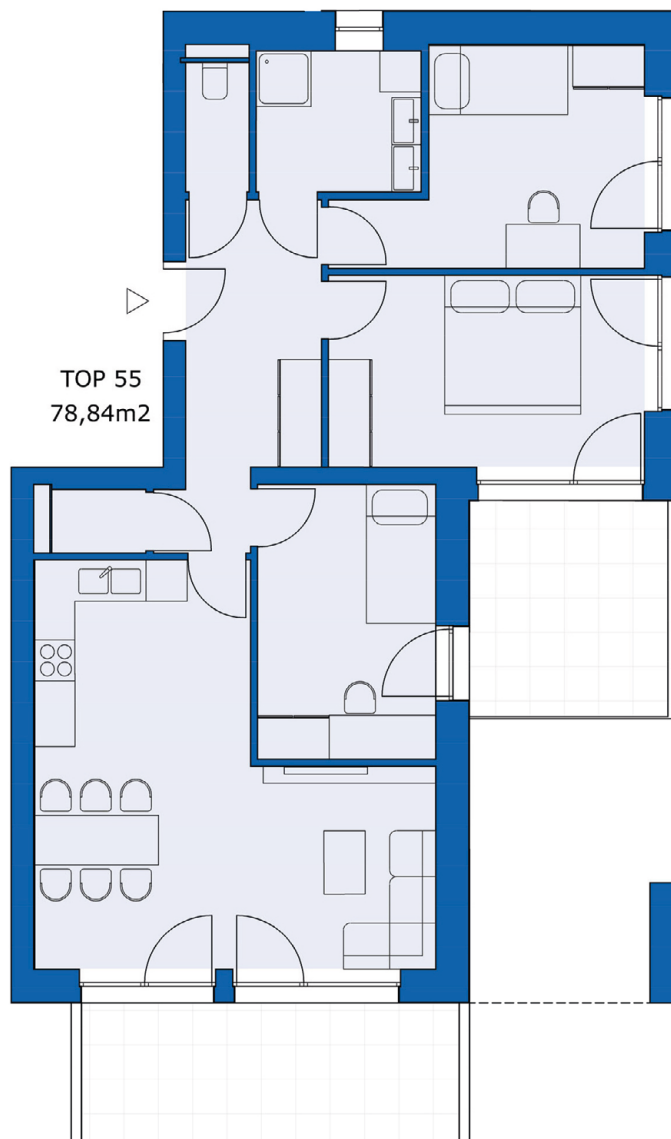

**Tiergartenweg 32a** | 8055 Graz

**TOP 55 / 2. OBERGESCHOSS**

Wohnfläche	78,84 m <sup>2</sup>
Balkon	20,09 m <sup>2</sup>
Kellerabteil	Nr. 55
Tiefgaragen-Stellplatz	Nr. 05

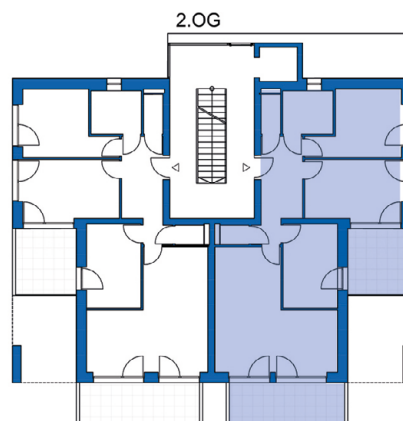



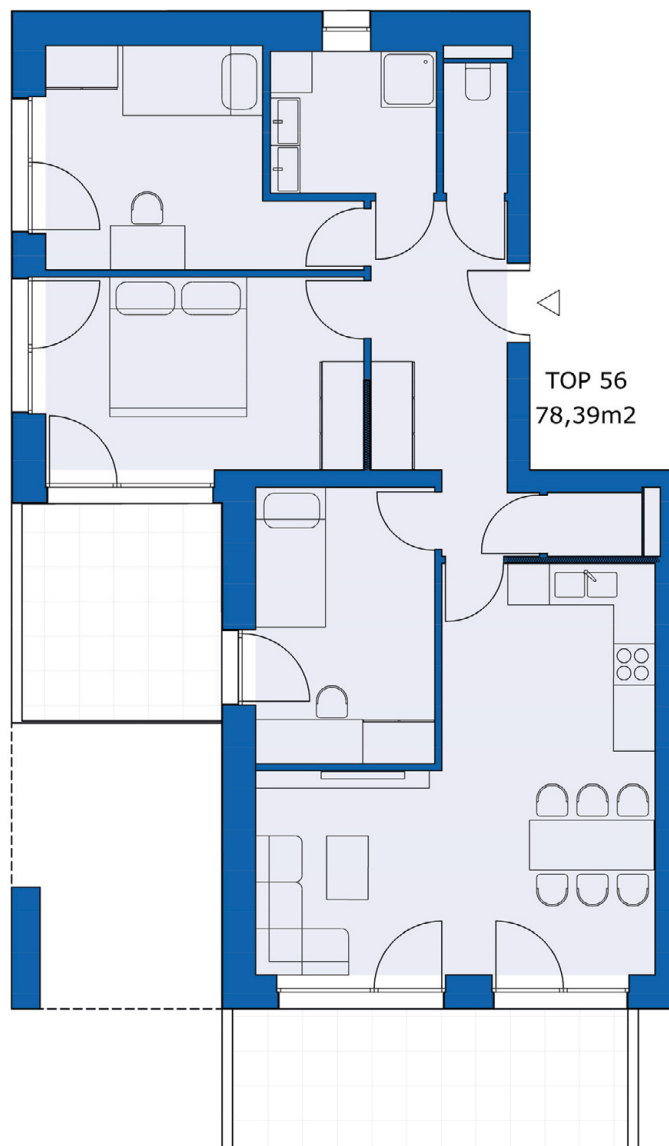

## Tiergartenweg 32a | 8055 Graz

### TOP 56 / 2. OBERGESCHOSS

Wohnfläche	78,39 m <sup>2</sup>
Balkon	20,13 m <sup>2</sup>
Kellerabteil	Nr. 56
Tiefgaragen-Stellplatz	Nr. 06

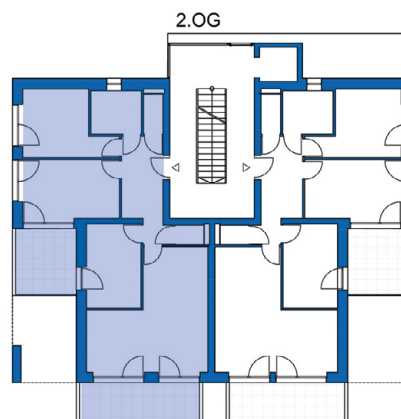

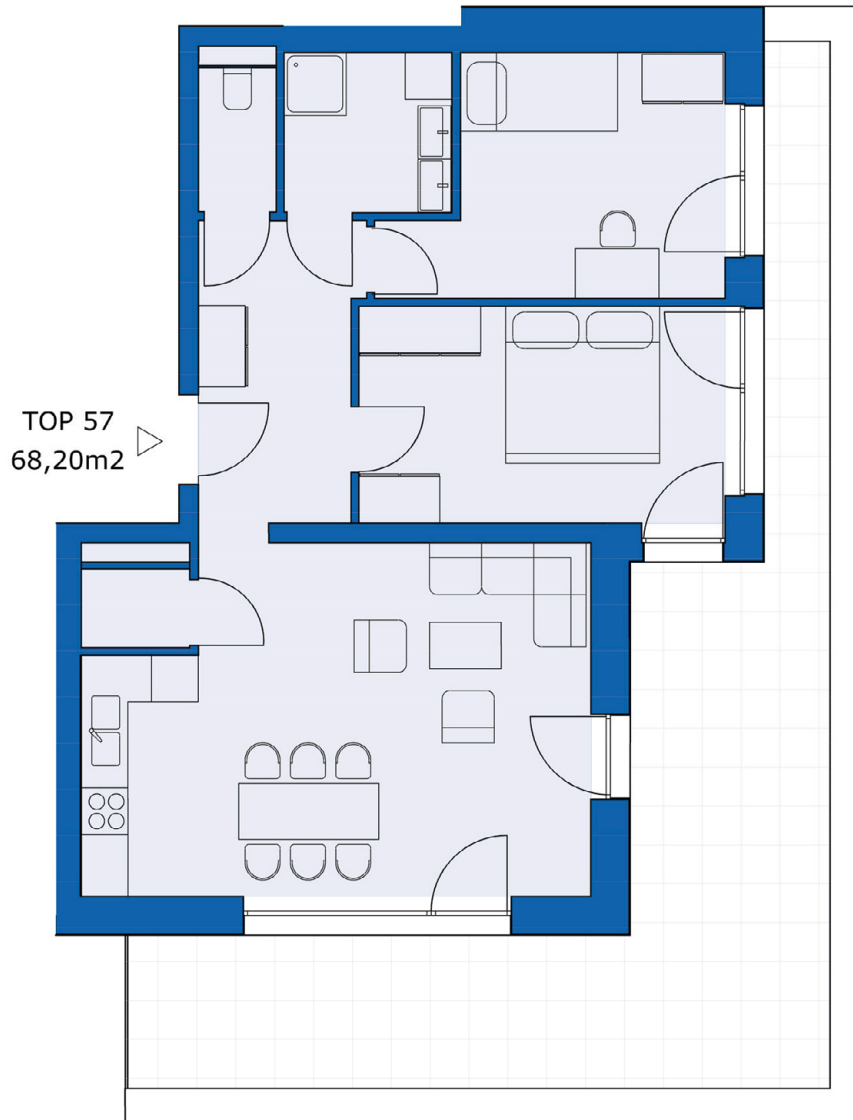

**Tiergartenweg 32a** | 8055 Graz

**TOP 57 / DACHGESCHOSS**

Wohnfläche	68,20 m <sup>2</sup>
Terrasse	34,62 m <sup>2</sup>
Kellerabteil	Nr. 57
Tiefgaragen-Stellplatz	Nr. 07

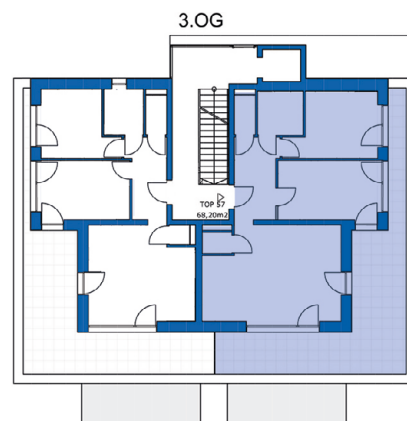

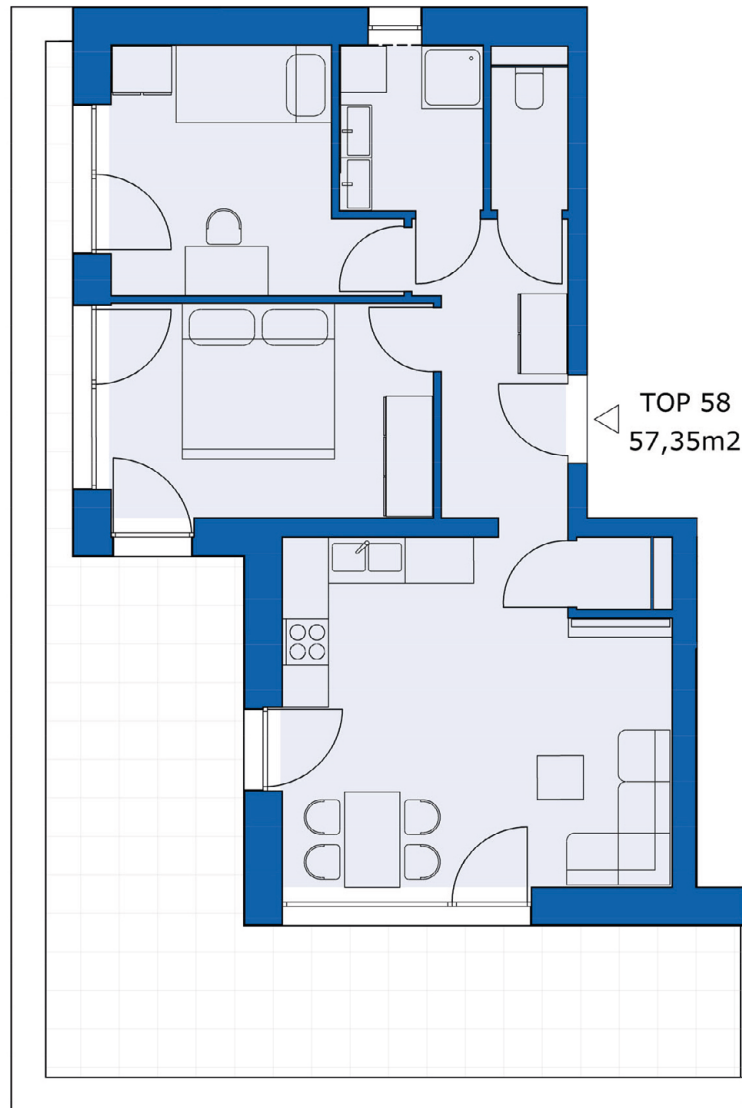

**Tiergartenweg 32a** | 8055 Graz

**TOP 58 / DACHGESCHOSS**

Wohnfläche	57,35 m <sup>2</sup>
Terrasse	32,16 m <sup>2</sup>
Kellerabteil	Nr. 58
Tiefgaragen-Stellplatz	Nr. 08

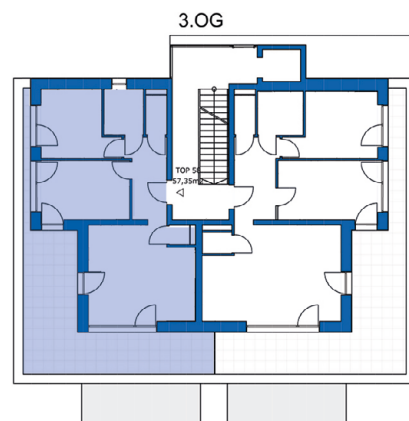

**IFA** | Institut für  
Anlageberatung

IFA Institut für Anlageberatung AG

Grillparzerstraße 18-20  
A-4020 Linz  
+43 732 660 847  
office@ifa.at  
www.ifa.at